



US008611920B2

(12) **United States Patent**
Lau et al.

(10) **Patent No.:** **US 8,611,920 B2**
(45) **Date of Patent:** **Dec. 17, 2013**

(54) **METHOD AND APPARATUS FOR LOCATION IDENTIFICATION**

(75) Inventors: **Chung Lau**, Sunnyvale, CA (US); **Peter P. Tong**, Mountain View, CA (US); **C. Douglass Thomas**, Campbell, CA (US)

(73) Assignee: **IpVenture, Inc.**, Los Altos, CA (US)

(*) Notice: Subject to any disclaimer, the term of this patent is extended or adjusted under 35 U.S.C. 154(b) by 707 days.

(21) Appl. No.: **11/705,339**

(22) Filed: **Feb. 10, 2007**

(65) **Prior Publication Data**

US 2008/0021645 A1 Jan. 24, 2008

Related U.S. Application Data

(63) Continuation of application No. 10/397,472, filed on Mar. 26, 2003, now Pat. No. 7,218,938, which is a continuation-in-part of application No. 09/797,517, filed on Feb. 28, 2001, now Pat. No. 7,366,522.

(60) Provisional application No. 60/185,480, filed on Feb. 28, 2000, provisional application No. 60/444,198, filed on Jan. 30, 2003, provisional application No. 60/418,491, filed on Oct. 15, 2002, provisional application No. 60/404,645, filed on Aug. 19, 2002, provisional application No. 60/375,998, filed on Apr. 24, 2002.

(51) **Int. Cl.**
H04W 24/00 (2009.01)

(52) **U.S. Cl.**
USPC **455/456.1**; 455/456.2; 455/456.3;
455/404.2; 455/414.2; 455/440; 340/539.13;
340/988

(58) **Field of Classification Search**
USPC 455/456.1, 456.2, 456.3, 404.2, 414.2,
455/440; 340/539.13, 825.49, 988;
342/357.01, 357.06, 357.07, 357.13,
342/457; 701/213, 214, 215

See application file for complete search history.

(56) **References Cited**

U.S. PATENT DOCUMENTS

5,337,579 A 8/1994 Saia, III et al.
5,347,274 A 9/1994 Hassett

(Continued)

FOREIGN PATENT DOCUMENTS

EP 0 874 529 A2 10/1998
EP 1 037 447 A2 9/2000

(Continued)

OTHER PUBLICATIONS

“352C22 Miniature Low Profile ICP Accelerometer,” Precision Accelerometers, PCB Piezoelectronics Products—SVS Division, webpages, pp. 1-2 (downloaded Apr. 11, 2002: www.pcb.com/products/svs/svs352c22.html).

(Continued)

Primary Examiner — Quynh Nguyen

(57) **ABSTRACT**

Method and apparatus to analyze and present location information in an easy-to-digest manner are disclosed. In one embodiment, each piece of location information can include a piece of location-designating information and a piece of location-related information. Location-designating information is primarily for identifying location. Location-related information is information related to location-designating information. The location-designating information and the location-related information can be supplied by a mobile device. With the help of location-related information, each piece of location-designating information can be more accurately transformed into a label to help identify a location. The amount of location information can be reduced. All of the location-designating information pertaining to a given area can be consolidated into one piece of location-designating information related to the label. Consolidation of some of the information may not occur if a piece of location-related information changes by more than a preset value. To better present location information in an easy-to-digest manner, location information can be compared to standards. Presentation can be on a display with respect to a reference location.

60 Claims, 11 Drawing Sheets

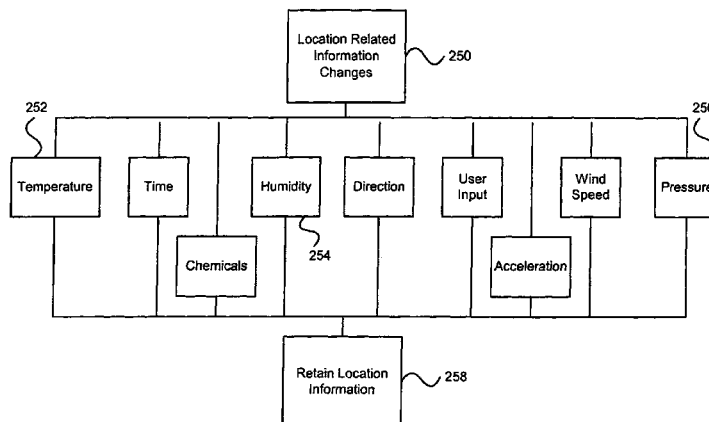

(56)

References Cited

U.S. PATENT DOCUMENTS

5,389,934	A	2/1995	Kass	6,064,336	A	5/2000	Krasner	
5,400,020	A	3/1995	Jones et al.	6,067,018	A	5/2000	Skelton et al.	
5,461,365	A	10/1995	Schlager et al.	6,067,044	A	5/2000	Whelan et al.	
5,491,486	A	2/1996	Welles, II et al.	6,072,396	A	6/2000	Gaukel	
5,512,902	A	4/1996	Guthrie et al.	6,078,290	A	6/2000	McBurney et al.	
5,515,858	A	5/1996	Mylymaki	6,083,248	A	7/2000	Thompson	
5,528,247	A	6/1996	Nonami	6,083,353	A	7/2000	Alexander	
5,528,518	A	6/1996	Bradshaw et al.	6,094,168	A	7/2000	Duffett-Smith et al.	
5,532,690	A	7/1996	Hertel	6,100,806	A	8/2000	Gaukel	
5,539,748	A	7/1996	Raith	6,101,710	A	8/2000	Selinger	
5,541,845	A	7/1996	Klein	6,111,540	A	8/2000	Krasner	
5,550,551	A	8/1996	Alesio	6,115,595	A	9/2000	Rodal et al.	
5,568,119	A	10/1996	Schipper et al.	6,121,921	A	9/2000	Ishigaki	
5,570,412	A	10/1996	LeBlanc	6,131,067	A	10/2000	Girerd et al.	
5,576,716	A	11/1996	Sadler	6,140,863	A	10/2000	Fujisawa	
5,592,173	A	1/1997	Lau et al.	6,141,570	A	10/2000	O'Neill, Jr. et al.	
5,598,460	A	1/1997	Tendler	6,144,303	A	11/2000	Federman	
5,604,708	A	2/1997	Helms et al.	6,148,280	A	11/2000	Kramer	
5,623,260	A	4/1997	Jones	6,154,422	A	11/2000	Shinkawa et al.	
5,623,418	A	4/1997	Rostoker	6,163,696	A	12/2000	Bi et al.	
5,629,678	A	5/1997	Gargano et al.	6,171,264	B1	1/2001	Bader	
5,633,874	A	5/1997	Diachina et al.	6,172,640	B1	1/2001	Durst et al.	
5,650,770	A	7/1997	Schlager et al.	6,175,616	B1	1/2001	Light et al.	
5,652,570	A	7/1997	Lepkofker	6,198,390	B1	3/2001	Schlager et al.	
5,673,692	A	10/1997	Schulze et al.	6,198,431	B1	3/2001	Gibson	
5,686,888	A	11/1997	Welles, II et al.	6,198,930	B1	3/2001	Schipper	
5,710,551	A	1/1998	Ridgeway	6,199,045	B1	3/2001	Giniger et al.	
5,712,619	A	1/1998	Simkin	6,212,133	B1	4/2001	McCoy et al.	
5,731,757	A	3/1998	Layson et al.	6,226,622	B1	5/2001	Dabbieri	
5,731,788	A	3/1998	Reeds	6,231,519	B1	5/2001	Blants et al.	
5,742,233	A	4/1998	Hoffman et al.	6,232,916	B1	5/2001	Grillo et al.	
5,751,245	A	5/1998	Janky et al.	6,236,358	B1	5/2001	Durst et al.	
5,771,001	A	6/1998	Cobb	6,238,337	B1	5/2001	Kambhatla et al.	
5,771,455	A	6/1998	Kennedy, III et al.	6,243,039	B1	6/2001	Elliot	
5,774,876	A	6/1998	Woolley et al.	6,243,660	B1 *	6/2001	Hsu et al. 702/160	
5,797,091	A	8/1998	Clise et al.	6,246,376	B1	6/2001	Bork et al.	
5,808,565	A	9/1998	Matta et al.	6,252,543	B1	6/2001	Camp	
RE35,920	E	10/1998	Sorden et al.	6,263,280	B1	7/2001	Stingone, Jr.	
5,825,283	A	10/1998	Camhi	6,278,936	B1	8/2001	Jones	
5,826,195	A	10/1998	Westerlage et al.	6,281,797	B1	8/2001	Forster	
5,835,907	A	11/1998	Newman	6,282,362	B1	8/2001	Murphy et al.	
5,841,352	A	11/1998	Prakash	6,282,495	B1	8/2001	Kirkhart et al.	
5,844,862	A	12/1998	Cocatre-Zilgien	6,292,687	B1	9/2001	Lowell et al.	
5,850,196	A	12/1998	Mowers	6,298,306	B1	10/2001	Suarez et al.	
5,861,841	A	1/1999	Gildea et al.	6,300,875	B1	10/2001	Schafer	
5,883,594	A	3/1999	Lau	6,302,844	B1	10/2001	Walker et al.	
5,889,770	A	3/1999	Jokiaho et al.	6,304,467	B1	10/2001	Nebritic	
5,892,454	A	4/1999	Schipper et al.	6,314,308	B1	11/2001	Sheynblat et al.	
5,905,461	A	5/1999	Neher	6,317,049	B1	11/2001	Toubia et al.	
5,910,799	A	6/1999	Carpenter et al.	6,323,807	B1	11/2001	Golding et al.	
5,913,078	A	6/1999	Kimura et al.	6,324,213	B1	11/2001	Harrison	
5,917,433	A	6/1999	Keillor et al.	6,327,533	B1	12/2001	Chou	
5,918,180	A	6/1999	Dimino	6,331,817	B1	12/2001	Goldberg	
5,938,721	A	8/1999	Dussell et al.	6,339,397	B1	1/2002	Baker	
5,948,040	A	9/1999	DeLorme et al.	6,340,928	B1	1/2002	McCurdy	
5,948,043	A	9/1999	Mathis	6,342,847	B1	1/2002	Archuleta et al.	
5,959,575	A	9/1999	Abbott	6,349,257	B1	2/2002	Liu et al.	
5,959,577	A	9/1999	Fan et al.	6,353,390	B1	3/2002	Beri et al.	
5,963,130	A	10/1999	Schlager et al.	6,353,798	B1	3/2002	Green et al.	
5,982,285	A	11/1999	Bueche et al.	6,356,841	B1	3/2002	Hamrick et al.	
5,982,807	A	11/1999	Snell	6,362,778	B2	3/2002	Neher	
5,983,108	A	11/1999	Kennedy, III et al.	6,363,254	B1	3/2002	Jones et al.	
5,991,690	A	11/1999	Murphy	6,363,323	B1	3/2002	Jones	
5,995,849	A	11/1999	Williams et al.	6,373,430	B1	4/2002	Beason et al.	
6,002,363	A	12/1999	Krasner	6,377,810	B1	4/2002	Geiger et al.	
6,002,982	A	12/1999	Fry	6,388,612	B1	5/2002	Neher	
6,009,319	A	12/1999	Khullar et al.	6,393,346	B1	5/2002	Keith et al.	
6,013,007	A	1/2000	Root et al.	6,404,352	B1	6/2002	Ichikawa et al.	
6,014,080	A	1/2000	Layson, Jr.	6,407,698	B1	6/2002	Ayed	
6,014,090	A	1/2000	Rosen et al.	6,411,892	B1	6/2002	Van Diggelen	
6,023,241	A	2/2000	Clapper	6,411,899	B2	6/2002	Dussell et al.	
6,031,496	A	2/2000	Kuittinen	6,421,538	B1	7/2002	Byrne	
6,032,051	A	2/2000	Hall et al.	6,426,719	B1	7/2002	Nagareda et al.	
6,034,622	A	3/2000	Levine	6,427,120	B1	7/2002	Garin et al.	
6,054,928	A *	4/2000	Lemelson et al. 340/573.4	6,430,602	B1	8/2002	Kay et al.	
				6,433,732	B1	8/2002	Dutta et al.	
				6,434,396	B1 *	8/2002	Rune 455/502	
				6,441,778	B1	8/2002	Durst et al.	
				6,442,380	B1	8/2002	Mohindra	

(56)

References Cited

U.S. PATENT DOCUMENTS

6,442,391 B1 8/2002 Johansson et al.
 6,443,890 B1 9/2002 Schulze et al.
 6,445,937 B1 9/2002 daSilva
 6,453,237 B1 9/2002 Fuchs et al.
 6,463,272 B1 10/2002 Wallace et al.
 6,466,821 B1 10/2002 Pianca et al.
 6,469,639 B2 10/2002 Tanenhaus et al.
 6,471,087 B1 10/2002 Shusterman
 6,478,736 B1 11/2002 Mault
 6,496,775 B2 12/2002 McDonald, Jr. et al.
 6,505,048 B1 1/2003 Moles et al.
 6,505,049 B1 1/2003 Dorenbosch
 6,513,532 B2 2/2003 Mault et al.
 6,522,871 B1 2/2003 Patrick et al.
 6,522,889 B1 2/2003 Aarnio
 6,529,164 B1 3/2003 Carter
 6,544,193 B2 4/2003 Abreu
 6,552,652 B2 4/2003 Beken
 6,553,336 B1 4/2003 Johnson et al.
 6,559,620 B2 5/2003 Zhou et al.
 6,569,094 B2 5/2003 Suzuki et al.
 6,571,193 B1 5/2003 Unuma et al.
 6,579,231 B1 6/2003 Phipps
 6,579,844 B1 6/2003 Morrison et al.
 6,611,688 B1 8/2003 Raith
 6,625,437 B1 9/2003 Jampolsky et al.
 6,630,885 B2 10/2003 Hardman et al.
 6,640,085 B1 10/2003 Chatzipetros et al.
 6,650,907 B1 11/2003 Kamperschroer et al.
 6,661,372 B1 12/2003 Girerd et al.
 6,679,071 B1 1/2004 Storey et al.
 6,696,982 B2 2/2004 Yoshioka et al.
 6,714,791 B2 3/2004 Friedman
 6,721,542 B1 4/2004 Anttila et al.
 6,741,927 B2 5/2004 Jones
 6,747,675 B1 6/2004 Abbott et al.
 6,748,318 B1 6/2004 Jones
 6,788,766 B2 9/2004 Logan
 6,801,853 B2 10/2004 Workman
 6,804,606 B2 10/2004 Jones
 6,847,892 B2 1/2005 Zhou et al.
 6,856,804 B1 2/2005 Ciotta
 6,865,385 B1 3/2005 Kohda et al.
 6,937,900 B1 8/2005 Planca et al.
 6,952,645 B1 10/2005 Jones
 6,975,941 B1 12/2005 Lau et al.
 6,980,826 B2* 12/2005 Yamaguchi 455/556.1
 7,010,144 B1* 3/2006 Davis et al. 382/100
 7,071,842 B1 7/2006 Brady, Jr.
 7,085,253 B2 8/2006 Yang
 7,110,773 B1 9/2006 Wallace et al.
 7,136,832 B2 11/2006 Li et al.
 7,187,278 B2 3/2007 Biffar
 7,212,829 B1 5/2007 Lau et al.
 7,218,938 B1 5/2007 Lau et al.
 7,253,731 B2 8/2007 Joao
 7,321,774 B1 1/2008 Lau et al.
 7,325,061 B2* 1/2008 Haruki 709/226
 7,366,522 B2 4/2008 Thomas
 7,403,972 B1 7/2008 Lau et al.
 7,539,557 B2 5/2009 Yamauchi
 7,809,377 B1 10/2010 Lau et al.
 7,905,832 B1 3/2011 Lau et al.
 7,953,809 B2 5/2011 Lau et al.
 8,176,135 B2 5/2012 Lau et al.
 8,285,484 B1 10/2012 Lau et al.
 8,301,158 B1 10/2012 Thomas
 2001/0006891 A1 7/2001 Cho
 2001/0020204 A1 9/2001 Runyon et al.
 2001/0027378 A1 10/2001 Tennison et al.
 2001/0027525 A1 10/2001 Gamlin
 2001/0028304 A1 10/2001 I'Anson et al.
 2001/0044299 A1 11/2001 Sandegren
 2001/0044332 A1 11/2001 Yamada et al.
 2001/0047125 A1 11/2001 Quy

2001/0052849 A1 12/2001 Jones, Jr.
 2002/0000930 A1 1/2002 Crowson et al.
 2002/0016173 A1 2/2002 Hunzinger
 2002/0027507 A1 3/2002 Yarin et al.
 2002/0028988 A1 3/2002 Suzuki et al.
 2002/0036593 A1 3/2002 Ying
 2002/0038182 A1 3/2002 Wong et al.
 2002/0049742 A1 4/2002 Chan et al.
 2002/0050945 A1 5/2002 Tsukishima et al.
 2002/0057192 A1 5/2002 Eagleson et al.
 2002/0063622 A1 5/2002 Armstrong et al.
 2002/0071677 A1* 6/2002 Sumanaweera 396/429
 2002/0077080 A1 6/2002 Greene
 2002/0087260 A1 7/2002 Hancock et al.
 2002/0087619 A1 7/2002 Tripathi
 2002/0094067 A1 7/2002 August
 2002/0111171 A1 8/2002 Boesch et al.
 2002/0111819 A1 8/2002 Li et al.
 2002/0115453 A1 8/2002 Poulin et al.
 2002/0116080 A1 8/2002 Birnbach et al.
 2002/0119770 A1 8/2002 Twitchell, Jr.
 2002/0119789 A1 8/2002 Friedman
 2002/0120475 A1 8/2002 Morimoto
 2002/0120503 A1 8/2002 Iwayama et al.
 2002/0140081 A1 10/2002 Chou et al.
 2002/0173910 A1 11/2002 McCall et al.
 2002/0193121 A1 12/2002 Nowak et al.
 2003/0003943 A1 1/2003 Bajikar
 2003/0009410 A1 1/2003 Ramankutty et al.
 2003/0013445 A1 1/2003 Fujiwara et al.
 2003/0069759 A1 4/2003 Smith
 2003/0083011 A1 5/2003 Haller et al.
 2003/0095540 A1 5/2003 Mulligan et al.
 2003/0151507 A1 8/2003 Andre et al.
 2003/0163287 A1 8/2003 Vock
 2003/0204132 A1 10/2003 Suzuki et al.
 2004/0034470 A1 2/2004 Workman
 2004/0046637 A1 3/2004 Wesby Van Swaay
 2004/0114731 A1 6/2004 Gillett et al.
 2004/0117108 A1 6/2004 Nemeth
 2004/0233065 A1 11/2004 Freeman
 2006/0173444 A1 8/2006 Choy et al.
 2007/0156286 A1 7/2007 Yamauchi
 2008/0261636 A1 10/2008 Lau et al.
 2009/0042540 A1* 2/2009 Bodnar et al. 455/410
 2011/0022533 A1 1/2011 Lau et al.
 2011/0223884 A1 9/2011 Lau et al.
 2012/0220266 A1 8/2012 Lau et al.

FOREIGN PATENT DOCUMENTS

EP 1 037 447 A3 10/2001
 JP 11-64482 3/1999
 JP 11-258325 9/1999
 JP 11-289574 10/1999
 JP 11-306491 11/1999
 WO WO 97/14054 4/1997
 WO WO 97/41654 11/1997
 WO WO 98/01769 A1 1/1998
 WO WO 98/16045 4/1998
 WO WO 98/40837 9/1998
 WO WO 00/51391 8/2000
 WO WO 01/50151 A1 7/2001
 WO WO 01/63318 8/2001
 WO WO 01/75700 A2 10/2001
 WO WO 02/42979 A1 5/2002
 WO WO 02/084618 A1 10/2002
 WO WO 03/012720 A1 2/2003

OTHER PUBLICATIONS

"3G Mobile Internet Revolution, . . . only with Location Based Services!" pp. 1, (downloaded Aug. 10, 2002: <http://webhome.idirect.com/~dental/3glocator/home.htm>).
 "Airline Cargo Containers," Case Study, RJI Incorporated, webpages, pp. 1-2 (downloaded Mar. 16, 2002: www.rji.cc/casestudies/airlinecargocounters.html).

(56)

References Cited

OTHER PUBLICATIONS

- "Airline Food Carts," Case Study, RJI Incorporated, webpages, pp. 1-2 (downloaded Mar. 16, 2002: www.rji.cc/casestudies/airlinefoodcarts.html).
- "An Introduction to SnapTrack Server-Aided GPS Technology," SnapTrack Inc., Feb. 10, 2007.
- "Audiovox Intros GPS, Bluetooth Phone," INT Media Group, Inc. (allNetDevices), Apr. 5, 2002. (downloaded: www.allnetdevices.com/wireless/news/2001/1/15/audiovox_intros.html).
- "Carrier and end-user applications for wireless location systems," TruePosition, Inc., pp. 1-7, Feb. 10, 2007.
- "Danger-Products" and "HipHop Communicator Brochure," Danger, Inc., downloaded Oct. 26, 2003: www.danger.com/products.php.
- "Developing a GPSs for the Global Supply Chain," Aberdeen Group, Inc., Executive White Paper, Jun. 2002.
- "Devices for Text Messages in Deutsche Telekom's fixed network have already found their way into many households," Deutsche Telekom AG, Press Release, Mar. 13, 2002, pp. 1-2.
- "Digital/Analog Compass Sensors" and "1655 Digital Compass Sensor," webpages, The Robson Company, Inc., pp. 1-2 (downloaded Apr. 11, 2002: www.dinsmoresensors.com/index.html).
- "EarthTrack™ Vehicle Tracking Systems," Outfitter Satellite, Inc., 1998 (downloaded Jan. 22, 2000).
- "Enhanced Tracking," United Parcel Service of America, Inc. (UPS), webpages, pp. 1-2 (downloaded Jun. 1, 2002: www.ups.com/myupsinfo/info/etrack?pnav=stdservice).
- "Fleet Management Systems-Asset Tracking Devices," Axiom Navigation Inc., 2000-2001 (downloaded Oct. 19, 2002: www.axiomnav.com/Prod_Systems/prod_system.asp).
- "Frozen Food Warehouse," Case Study, RJI Incorporated, webpages, pp. 1-3 (downloaded Mar. 16, 2002: www.rji.cc/casestudies/frozenfoodwarehouse.html).
- "FunMail Launches on the NTT DoCoMo i-mode network," FunMail, Press Release, May 1, 2001, pp. 1-2.
- "Global Cell Phone Location," Axiom Navigation Inc., 2000-2001 (downloaded Oct. 19, 2002: www.axiomnav.com/Prod_Global/prod_global.asp).
- "Global Locating Services," SkyBitz, webpage, p. 1, (downloaded Nov. 15, 2002: www.skybitz.com/services/gls.html).
- "GLS Communicator," SkyBitz, webpages, pp. 1-2, (downloaded Nov. 15, 2002: www.skybitz.com/gls/communicator.html).
- "Guide to Tracking Info.," Nippon Express, website page, p. 1 (downloaded Jun. 9, 2002: www.nittsu.co.jp/edoc/howtoe.htm).
- "Introduction to SMS," by C. Tull of Anywhere YouGo.com, pp. 1-4 (downloaded: www.devx.com/wireless/articles/SMS/SMSintro.asp), Feb. 10, 2007.
- "IO Data Develops GPS Adapter for I-Mode Mobile," AsiaBizTech, Sep. 17, 2002, pp. 1-2.
- "Locate Networks: Our Service," Locate Networks, webpages, pp. 1-7 (downloaded Sep. 26, 2002: www.locatenetworks.com/).
- "MMS phones: Don't believe the hype," CNN.com/SCI-TECH, Aug. 8, 2002, pp. 1-3.
- "Mobile Location Based Services: Cell Tracking Devices of People & Thongs . . .," pp. 1-2, (downloaded Aug. 10, 2002: <http://3glocate.com>).
- "MoniTrack," Case Study, RJI Incorporated, webpages, pp. 1-2 (downloaded Mar. 16, 2002: www.rji.cc/technology/telematic.html).
- "MY UPS.COM Benefits," United Parcel Service of America, Inc. (UPS), webpage, p. 1 (downloaded Apr. 13, 2002: www.ups.com/myupsinfo/info/benefits?pnav=stdservice).
- "NavMate® Navigation System," Visteon Corporation, webpage, pp. 1-2 (downloaded Jun. 21, 2002: www.visteon.com/technology/automotive/navmate.html).
- "News," SkyBitz, webpages, pp. 1-8, (downloaded Nov. 15, 2002: www.skybitz.com/about/news.html).
- "Pakhound: Your Watchdog in the Shipping Industry," website pages, pp. 1-3 (downloaded Jun. 9, 2002: www.pakhound.com/fact.asp).
- "Parkwatch and Wherenet Unveil the First Amusement Visitor Locating system," ParkWatch, Press Release, Jun. 27, 2000.
- "pulver.com's Location Based Services Report," pulver.com, Inc., Oct. 2001, pp. 1-17 (downloaded Jun. 4, 2002: www.pulver.com/lbsreport/lastbsreport.02/oct01.txt).
- "Radio Frequency Identification (RFID)," Case Study, RJI Incorporated, webpage, p. 1 (downloaded Mar. 16, 2002: www.rji.cc/technology/rfid.html).
- "Real Time Location System (RTLS)," Case Study, RJI Incorporated, webpage, p. 1 (downloaded Mar. 16, 2002: www.rji.cc/technology/rtls.html).
- "Real-Time Warehouse Tracking," Case Study, RJI Incorporated, webpages, pp. 1-2 (downloaded Mar. 16, 2002: www.rji.cc/casestudies/rtwarehousetracking.html).
- "Savi Reusable Transport Container," Savi Technology, Inc., Apr. 30, 2002, pp. 1-2.
- "Send images to i-mode phones," Mobile Media Japan, 2001, pp. 1-3.
- "Ski Rental with Auto ID and Tracking," Case Study, RJI Incorporated, webpages, pp. 1-2 (downloaded Mar. 16, 2002: www.rji.cc/casestudies/skirentalcompany.html).
- "SnapTrack and SignalSoft Corp. Team Up to Trial Location-based Information Service for GSM Test Group," Press Release, SnapTrack Inc., Dec. 6, 1999.
- "SnapTrack Awarded Additional Key Patents for Enhanced GPS System," Press Release, SnapTrack Inc., Jan. 4, 2000.
- "Start-up crams single chip with phone, GPS and Bluetooth," CNET Network, Inc. (ZDNET), Mar. 22, 2002 (downloaded: <http://news.zdnet.co.uk/story/0,t284-x2107163,00.html>).
- "Status Icons/Messages," Yahoo! Messenger Help, Yahoo! Inc., 2002, pp. 1-2.
- "Technical Applications of Our Current Technology," Aetherwire, webpages, pp. 1-4 (downloaded Mar. 16, 2002: www.aetherwire.com/CDROM/General/app11.html).
- "The Always on Network," Position Paper, Nortel Networks, 2002.
- "Theme Park Visitors & Cashless Purchasing," Case Study, RJI Incorporated, webpages, pp. 1-2 (downloaded Mar. 16, 2002: www.rji.cc/casestudies/themepark.html).
- "Track Shipments—Detailed Results," FedEx, webpages, pp. 1-2 (downloaded Oct. 29, 2002: www.fedex.com).
- "Track Your FedEx Shipments via Email," FedEx, webpages, pp. 1-2 (downloaded Oct. 29, 2002: www.fedex.com).
- "Tracking Helpful Tips," United Parcel Service of America, Inc. (UPS), webpages, pp. 1-2 (downloaded Jun. 1, 2002: www.ups.com/tracking/nm_help.html).
- "Trimble and Rosum Team to Develop Universal Positioning Technology," Trimble Navigation, Inc., News Release, Feb. 27, 2003.
- "Turning Position Into Knowledge," SkyBitz, webpage, p. 1, (downloaded Nov. 15, 2002: www.skybitz.com).
- "UPS Package Tracking," United Parcel Service of America, Inc. (UPS), webpages, pp. 1-2 (downloaded Apr. 13, 2002: www.ups.com/tracking/tracking.html).
- "UPS Wireless Solutions," United Parcel Service of America, Inc. (UPS), webpage, p. 1 (downloaded Apr. 13, 2002: www.ups.com/myupsinfo/info/wireless?pnav=stdservice).
- "Welcome to Iship, Inc.," iShip, Inc., webpages, pp. 1-2, (downloaded Jun. 9, 2002: www.iship.com/).
- "Welcome to Traker Systems," Traker Systems, webpages, pp. 1-2 (downloaded Jun. 9, 2002: www.trakersystems.com).
- "What are Instant Messages?" Yahoo! Messenger Help, Yahoo! Inc., 2002, pp. 1, Feb. 10, 2007.
- "What is "3G" technology?," CNN.com/SCI-TECH, Oct. 22, 2001, pp. 1-3.
- "What is a Friend List?" Yahoo! Messenger Help, Yahoo! Inc., 2002, pp. 1.
- "Wherify Wireless and SiRF Team to Deliver Child Locator System," Wherify Wireless, Inc., Press Release, Mar. 19, 2001, pp. 1-2.
- "Wherify Wireless Breakthrough in Location-Based Services," Mobilemag.com, Feb. 28, 2001, p. 1.
- "Wherify Wireless GPS Locator for Kids User Guide," Wherify Wireless, Inc., 2003, pp. 1-106, Feb. 10, 2007.
- "Wherify Wireless Location Services," Wherify Wireless, Inc., webpages, pp. 1-5 (downloaded: Mar. 25, 2003: www.wherifywireless.com/prod_watches.htm).

(56)

References Cited

OTHER PUBLICATIONS

- "X-GPS™—Hybrid GPS Location Server Solution," Axiom Navigation Inc., 2000-2001 (downloaded Oct. 19, 2002: www.axiomnav.com/Prod_Global/x-gps.asp).
- "Yahoo! Messenger—Sending Messages to a Mobile Phone," Yahoo! Messenger, Yahoo! Inc., 2002, pp. 1-7 (downloaded Oct. 27, 2002: [http://messenger.yahoo.com/messenger/wireless/pc2sms/tour1.html\(through/tour7.html\)](http://messenger.yahoo.com/messenger/wireless/pc2sms/tour1.html(through/tour7.html))).
- "Yahoo! Messenger for Text Messaging," Yahoo! Messenger, Yahoo! Inc., 2002, pp. 1-10 (downloaded Oct. 27, 2002: [http://messenger.yahoo.com/messenger/wireless/smsmsg/tour1.html\(through/tour7.html\)](http://messenger.yahoo.com/messenger/wireless/smsmsg/tour1.html(through/tour7.html))).
- "Yahoo! Messenger for WAP," Yahoo Messenger, Yahoo! Inc., 2002 (tours 1-9), pp. 1-17 (downloaded Oct. 27, 2002: [www.messenger.yahoo.com/messenger/wireless/wap/tour1.html\(through/tour9.html\)](http://www.messenger.yahoo.com/messenger/wireless/wap/tour1.html(through/tour9.html))).
- Accelerometers—General Purpose, LP Series, Crossbow Technology, Inc., data sheet, pp. 1-3 (downloaded Apr. 11, 2002: www.xbow.com/Products/Accelerometers.htm).
- Bickers, "Eyes in the sky," SafeTzone Technology Corporation, webpages, 2001, pp. 1-3 (downloaded: www.safetzone.com/newsKiosk.asp), Feb. 10, 2007.
- Chertkoff, Rachel, "Vehicle Locator Systems," Pager Technology, pp. 1-2, 1998, Feb. 10, 2007.
- Commercial Uses for LoJack (webpage), LoJack Corporation, downloaded Jan. 22, 2000.
- Crossbow Product Guide—Accelerometers, Crossbow Technology, Inc., webpages, pp. 1-3 (downloaded Apr. 11, 2002: www.xbow.com/Products/Accelerometers.htm).
- Delphi and MobileAria Demonstrate True Hands Free In-Vehicle Mobile Productivity Services at CES, Press Release, Delphi Automotive Systems, Jan. 8, 2002 (downloaded Apr. 5, 2002: www.delphiauto.com/news/pressRelease/pr6828-01082002).
- F. Rivera, "Special Report: Keeping Tabs on Your Teen," 7 News, Boston, Apr. 30, 2002, pp. 1-3.
- FedEx Insight, FedEx, webpages, pp. 1-11 (downloaded Oct. 29, 2002: www.fedex.com).
- GPS2000, Omega Research and Development, Inc., webpages, pp. 1-9 (pp. 7-9 pertain to an online tour) (downloaded Jul. 14, 2003: www.gps2000online.com/).
- IMVironment, Yahoo! Messenger Yahoo! Inc., 2002, pp. 1-12 (downloaded (including) Oct. 27, 2002: [http://help.yahoo.com/help/us/mesg/imv/imv-01.html\(through/index5.html\)](http://help.yahoo.com/help/us/mesg/imv/imv-01.html(through/index5.html))).
- J.Wrolstad, "Chrysler Claims First With Bluetooth Mobile Phone System," Wireless Newsfactor, Oct. 26, 2001.
- K. Hill, "Prada Uses Smart Tags to Personalize Shopping," CRMDaily.com, Apr. 24, 2002., pp. 1-4.
- K. Miyake, "Sharp to unveil 3G PDA-type cell phone," ITworld.com, Inc., Jan. 11, 2002.
- Kleinknecht, William, "Juvenile authorities want satellite tracking for felons," The Star-Ledger of New Jersey, Nov. 18, 1997.
- LoadTrak, pp. 1-2 (downloaded Jun. 4, 2002: www.load-trak.com).
- Marek, "The Unstoppable SnapTrack," Wireless Week, Dec. 18, 2000.
- Motorola Consumer Catalog: Pagers (webpage), Motorola, Inc., downloaded Jan. 19, 2000.
- My.Roadway!, Roadway Express, Inc., webpages, pp. 1-2, (downloaded Jun. 9, 2002: www.quicktrak.roadway.com/cgi-bin/quicktrak).
- Packtrack™, PackTrack.com, webpages, pp. 1-2 (downloaded Jun. 9, 2002: www.packtrack.com).
- Precision Accelerometers, PCB Piezoelectronics Products—SVS Division, webpages, pp. 1-2 (downloaded Apr. 11, 2002: www.pcb.com/products/svs/index.html).
- Rabinowitz and Spilker, Jr., "A New Positioning System Using Television Synchronization Signals," Rosum Corporation, pp. 1-11 (downloaded May 21, 2003).
- Rabinowitz and Spilker, Jr., "Positioning Using the ATSC Digital Television Signal," Rosum Corporation Whitepaper, Rosum Corporation (downloaded May 21, 2003).
- Real Time Locating System, Executive Summary, Technology Systems International, Inc., Feb. 10, 2007.
- Ryan, "Catching up with Dick Tracy," San Francisco Chronicle, news article, Mar. 18, 2002.
- SandPiper GPS Receiver, Specification sheet by Axiom Navigation Inc. (www.axiomnav.com).
- Smart Antenna, Specification sheet by Axiom Navigation Inc. (www.axiomnav.com), Feb. 10, 2007.
- SnapTrack—Privacy Protection (webpage), SnapTrack Inc., downloaded Jan. 19, 2000.
- SnapTrack—Technology at Work (webpage), SnapTrack Inc., downloaded Jan. 19, 2000.
- SnapTrack in Action (webpage), SnapTrack Inc., downloaded Jan. 19, 2000.
- Stilp, Louis A., "Examining the Coming Revolution in Location Services," pp. 1-11.
- Swift A2 GPS Receiver, Specification sheet by Axiom Navigation Inc. (www.axiomnav.com), Feb. 10, 2007.
- Swift B2 GPS Receiver, Specification sheet by Axiom Navigation Inc. (www.axiomnav.com), Feb. 10, 2007.
- TruePosition Virtual Brochure (webpage), TruePosition, Inc., Feb. 10, 2007.
- Wong, "Fishers, golfers join the rush to GPS," San Jose Mercury News, news article, Mar. 25, 2002.
- Office Action for U.S. Appl. No. 10/397,472 dated Sep. 29, 2006.
- Notice of Allowance for U.S. Appl. No. 10/397,472, dated Dec. 6, 2006.
- Notice of Allowance for U.S. Appl. No. 10/397,472, dated Feb. 27, 2007.
- Archived page entitled "Money-Back Guarantee Policy" from fedex.com, archived by the Internet Archive on Aug. 17, 2000.
- Strom, Stephanie. "A Wild Sleigh Ride at Federal Express," the New York Times, Dec. 20, 1994.
- Sauer, Matthew, "Company Finds Niche by Giving Directions . . ." Sarasota Herald-Tribune (Florida), Section: Business Weekly, p. 1, Jul. 7, 1997.
- "ATX Technologies Signs Nationwide Service Deal with AT&T," Global Positioning & Navigation News, vol. 7, No. 9, May 7, 1997.
- "Car Thieves Take the 'Bait' in Tulsa; Two Suspects Caught Off Guard with OnGuard Once Again," PR Newswire, Section: Financial News, Jan. 8, 1997.
- "Car Thieves Take the 'Bait' in Tulsa; Two Suspects Caught Off Guard with on Guard," PR Newswire, Section: Financial News, Dec. 9, 1996.
- Jackson, Terry, "Smart Cars Whether by Satellite or the Internet, High-Tech Devices and Services May Make Crumpled Road Maps a Thing of the Past," The Miami Herald, Section: Travel, p. 1J, Oct. 6, 1996.
- "San Antonio Personal Security Company Links Up with Senior PGA Golfer," PR Newswire, Section: Financial News, Apr. 1, 1996.
- "San Antonio Personal Security Company Links Up with Senior PGA Golfer," Southwest Newswire, Apr. 1, 1996.
- Business Briefs, San Antonio Express-News, Mar. 25, 1996.
- "ATX Research Signs Exclusive Sales Agreement with Arizona Company," PR Newswire, Mar. 21, 1996.
- "ATX Research Signs Exclusive Sales Agreement with Arizona Company," Southwest Newswire, Mar. 21, 1996.
- "Automotive GPS Satellite/Safety System Race Is On," Southwest Newswire, Feb. 20, 1996.
- "Dealerships Can Track Down New Aftermarket Revenues," PR Newswire, Feb. 9, 1996.
- "ATX Research Unveils New Stealthtrac Capability," PR Newswire, Feb. 9, 1996.
- "Dealerships Can Track Down New Aftermarket Revenues," Southwest Newswire, Feb. 9, 1996.
- Briefs, Global Positioning & Navigation News Wire, vol. 6, No. 2, Jan. 24, 1996.
- "ATX Research Provides Police Departments With OnGuard Personal Security and Vehicle Tracking System," PR Newswire, Jan. 15, 1996.
- "ATX Research Provides Police Departments With OnGuard Personal Security and Vehicle Tracking System," Southwest Newswire, Jan. 15, 1996.

(56)

References Cited

OTHER PUBLICATIONS

- "ATX Research Relocates to New Corporate Headquarters," PR Newswire, Dec. 12, 1995.
- "ATX Research Relocates to New Corporate Headquarters," Southwest Newswire, Dec. 12, 1995.
- "Texas invention tracks stolen cars, lets driver call for help," The Vancouver Sun, Oct. 20, 1995.
- "San Antonio Company Unveils Satellite/Cellular Personal Security System," PR Newswire, Oct. 3, 1995.
- "San Antonio Company Unveils Satellite/Cellular Personal Security System," Southwest Newswire, Oct. 3, 1995.
- Culler et al., *MICA: The Commercialization of Microsensor Motes*, Sensors, vol. 19, No. 4 (Apr. 1, 2002).
- Darabi et al., *A 2.4-GHz CMOS Transceiver for Bluetooth*, IEEE Journal of Solid-State Circuits, vol. 36, No. 12 (Dec. 2001).
- J. Fraden, *Handbook of Modern Sensors*, Springer-Verlag (1996).
- Grimes, Craig A., et al., *Wireless Magnetoelastic Resonance Sensors: A Critical Review*, Sensors (Jul. 23, 2002).
- Helfenstein et al. *Circuits and Systems for Wireless Communications*, Kluwer Academic Publishers (2000).
- Hill et al., *System Architecture Directions for Networked Sensors*, ACM/ASPLOS-IX (Nov. 2000).
- Madou, Marc J., *Fundamentals of Microfabrication*, CRC Press (2002).
- Mainwaring et al., *Wireless Sensor Networks for Habitat Monitoring*, ACM (Sep. 28, 2002).
- Razavi, Behzad, *RF Microelectronics*, Prentice Hall (1998).
- Rofougaran et al., *A Single-Chip 900-MHz Spread-Spectrum Wireless Transceiver in 1- μ m CMOS-Part II: Receiver Design*, IEEE Journal of Solid-State Circuits, vol. 33, No. 4 (Apr. 1998).
- Senturia, Stephen D., *Microsystem Design*, Kluwer Academic Publishers (2001).
- Steyaert et al., "A 2-V CMOS Cellular Transceiver Front-End," *IEEE Journal of Solid-State Circuits*, vol. 25, No. 12, Dec. 2000, pp. 1895-1907.
- Danger Product Overview, 5 pgs., Danger, Inc., Feb. 10, 2007.
- PCVtrak™ Installation and Operator's Manual, Trimble Navigation, 24623-00 Rev. A, May 1994, pp. 1-259.
- "Advanced Traveler Aid Systems for Public Transportation," Final Report, Federal Transit Administration, Sep. 1994, pp. 1-131.
- Campbell, Laurel, "Security—Military satellite enlisted to thwart car crime," *The Commercial Appeal*, Sep. 26, 1996, pp. 5B.
- Law, Alex, "Week in Wheels/ . . . From a Driver's Notebook," *Newsday, Inc.*, Sep. 20, 1996, pp. C03.
- Cortez, Angela, "Springs police can track thief, vehicles," *The Denver Post*, Sep. 10, 1996, pp. B-01.
- "OnGuard Tracker Nabs Auto Burglar," *Global Positioning & Navigation News*, vol. 6, No. 16, Aug. 8, 1996.
- "OnGuard Tracker Nabs Auto Burglar," *Section: Financial News*, PR Newswire, Jul. 29, 1996.
- Nauman, Matt, "Pressing the Panic Button: Car Security Enters a New Age with Cellular Phones and Satellites that Watch Over You," *San Jose Mercury News*, Jun. 21, 1996, pp. 1G.
- "Monday Briefing" *San Antonio Express-News*, p. 1, Part B, Jun. 10, 1996.
- "OnGuard Tracker Makes Debut on 'One Lap of America,'" PR Newswire, Jun. 7, 1996.
- "OnGuard Tracker Makes Debut on 'One Lap of America,'" Southwest Newswire, Jun. 7, 1996.
- Dominguez, Raul, "Women get their day in sun—American Golf planning events nationwide May 18," *San Antonio Express-News*, Apr. 18, 1996, pp. 2, part B.
- "Vehicle Navigation Units Being Measured in Luxury Autos," *Global Positioning & Navigation News*, vol. 6, No. 7, Apr. 4, 1996.
- "Advanced Business Sciences, Inc. Announces Completion of Acquisition of Comguard of Illinois," *Business Wire*, Aug. 26, 1998.
- "Advanced Business Sciences, Inc. Announces Filing With Securities and Exchange Commission," *Business Wire*, Jun. 25, 1999.
- "Advanced Business Sciences, Inc. Announces Preliminary Fourth Quarter 1998 Revenue Results," *Business Wire*, Feb. 4, 1999.
- "Business People Burnsby's Grill Names Two," *Omaha World-Herald*, Section Business, p. 4M, Oct. 20, 1996.
- "Company Sees Prisoner Tracking and Monitoring Market Niche," *Global Positioning & Navigation News*, vol. 6, No. 10, May 16, 1996.
- GPS-Based Personal Monitoring Systems Offered to Corrections, Private Market, *Global Positioning & Navigation News*, vol. 8, No. 11, Jun. 3, 1998.
- GPS tracks parolees, probationers, *Corrections Professional*, vol. 5, No. 6, Nov. 19, 1999.
- High-Tech System Tracks Offenders—Satellites Watching Criminals, *Business Wire*, Nov. 14, 1997.
- Briefs, *Global Positioning & Navigation News*, vol. 9, No. 4, Feb. 24, 1999.
- Dunkelberger, Lloyd, "Lawmakers question criminal-tracking system," *Sarasota Herald-Tribune* (Florida), pp. 16A, Nov. 28, 1999.
- Powell, Barbara, "New gadgets help drivers find their way," *Fort Worth Star-Telegram* (Texas), p. 1, Jan. 20, 1997.
- "New Service Lets Corrections Agencies Track Offenders by Satellite," PR Newswire, Jan. 11, 1999.
- "New Service Lets Corrections Agencies Track Offenders by Satellite; SecurityLink Offers 'GPS' Tracking for Offenders on Electronic Monitoring—Sandusky Municipal Court Adopts Technology for Local Offenders," PR Newswire, Jan. 12, 1999.
- "New Service Lets Corrections Agencies Track Offenders by Satellite; SecurityLink Offers 'GPS' Tracking for Offenders on Electronic Monitoring," PR Newswire, Section: Financial News, Jan. 11, 1999.
- "New Service Lets Corrections Agencies Track Offenders by Satellite," *Satellite Today*, vol. 2, No. 8, Jan. 13, 1999.
- "Prisoner Security Monitoring Company Grabs Contracts for GPS-Based System," *Global Positioning & Navigation News*, vol. 7, No. 1, Jan. 15, 1997.
- Atwater, Andi, "Proposal seeking 24-hour tracking of all sex offenders," *The News-Press* (Fort Meyers, FL), pp. 1A, Feb. 20, 2000.
- Briefs, *Global Positioning & Navigation News*, vol. 9, No. 3, Feb. 10, 1999.
- Brauer, David, "Satellite 'Big Brother' Tracks Ex-Inmates; Agencies Experiment with GPS to Monitor Parolee Whereabouts," *Chicago Tribune*, Section: News, p. 31, Dec. 18, 1998.
- "Satellite Spotlight; Eye in the Sky to Monitor Parolees," *Satellite News*, vol. 21, No. 15, Apr. 13, 1998.
- "Satellite Spotlight: Fighting Crime From Space," *Satellite News*, vol. 19, No. 20, May 13, 1996.
- Prohaska, Thomas J., "Satellite Will Keep Tabs on Convicts," *Buffalo News* (New York), Section: Local, p. 5B, Sep. 20, 1999.
- "Sierra Wireless and Pro Tech Team Up on Monitoring Product," *Global Positioning & Navigation News*, vol. 8, No. 8, Apr. 22, 1998.
- Anderson, Larry, "Technology rules at Securing New Ground," *Access Control & Security Systems Integration*, Section: Industry Outlook; ISSN 1084-6425, Dec. 1999.
- Trimble Navigation Warns 2nd-Quarter Earnings to Miss Target, *Dow Jones Business News*, Jul. 10, 1998.
- "Trimble Navigation's Net Income Skipped 93% Amid Order Delays," *Dow Jones Business News*, Jul. 23, 1998.
- Briefs, *Global Positioning & Navigation News*, vol. 9, No. 2, Jan. 27, 1999.
- Briefs, *Global Positioning & Navigation News*, vol. 9, No. 14, Jul. 14, 1999.
- Dailey et al. "Automatic Transit Location System," Final Research Report, 55 pgs., Feb. 1996.
- Maguire, Jr. et al. "SmartBadges: a wearable computer and communication system," *codes/CASHE '98*, 47 pgs., 1998.
- Koshima et al. "Personal locator services emerge," *IEEE Spectrum*, Feb. 2000, pp. 41-48.
- Zygowicz et al. "State of the Art in Automatic Vehicle Location Systems," Center for Urban Transportation Studies, University of Wisconsin, Milwaukee, Feb. 1998.
- Ashworth, Jon. "Big brother is watching you," *The Times* (London), Section: Features, May 7, 1999.
- "Car Thieves Take the 'Bait' in Michigan; Two Suspects Reeled in With OnGuard," *Business Wire*, Sep. 11, 1997.

* cited by examiner

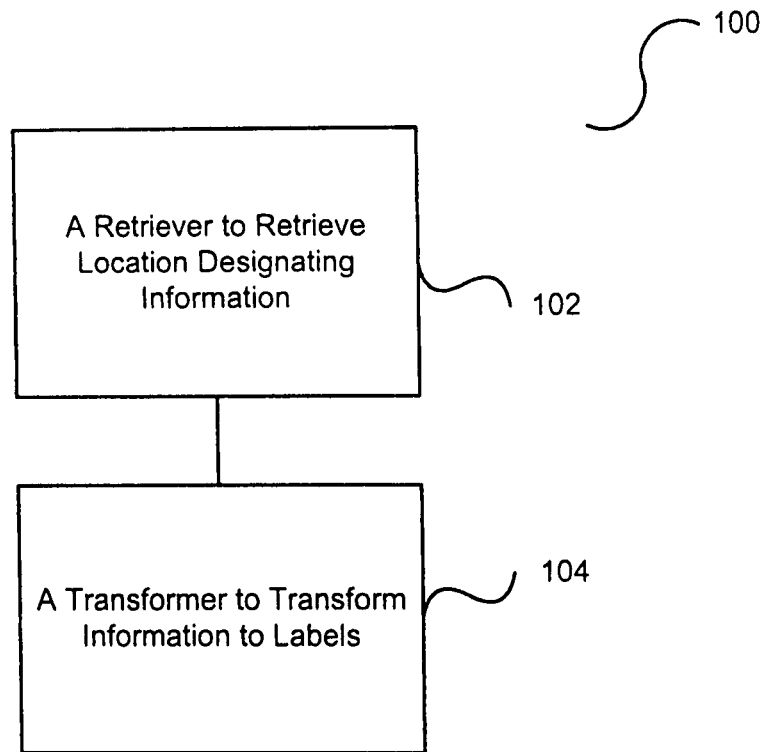

Figure 1(a)

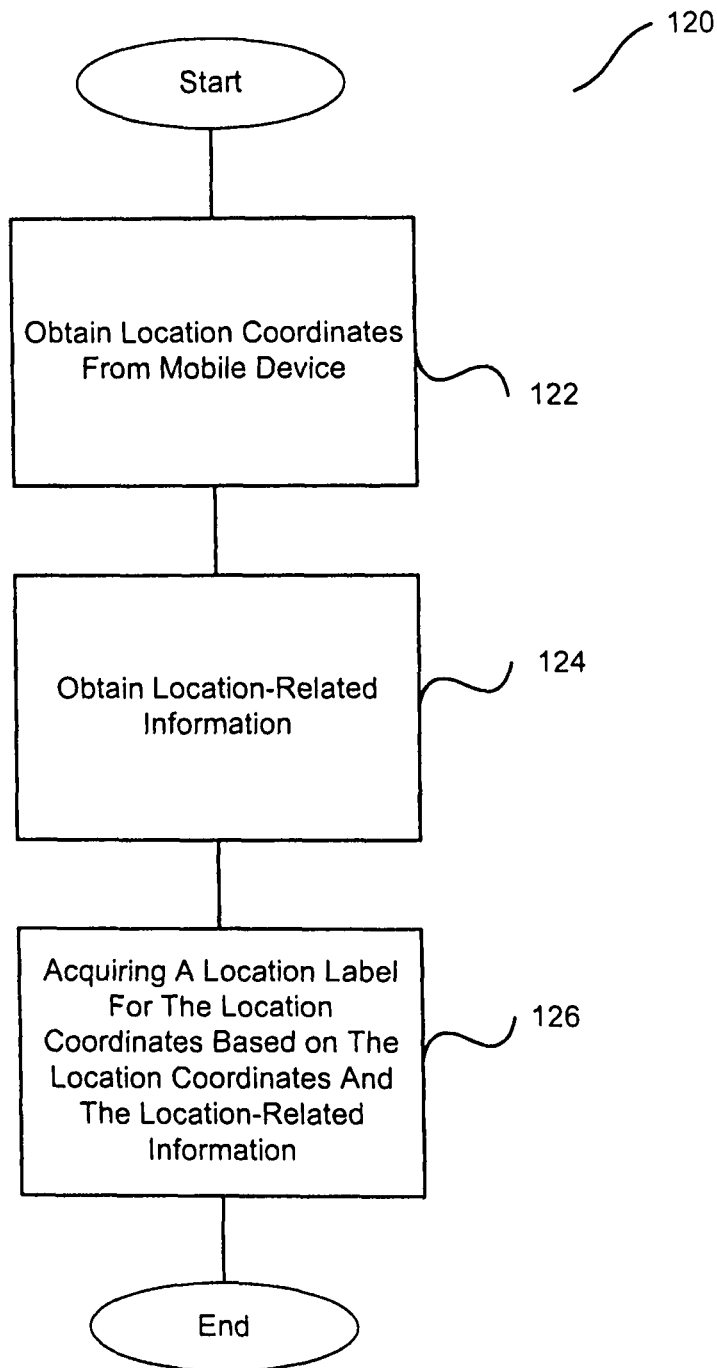

Figure 1(b)

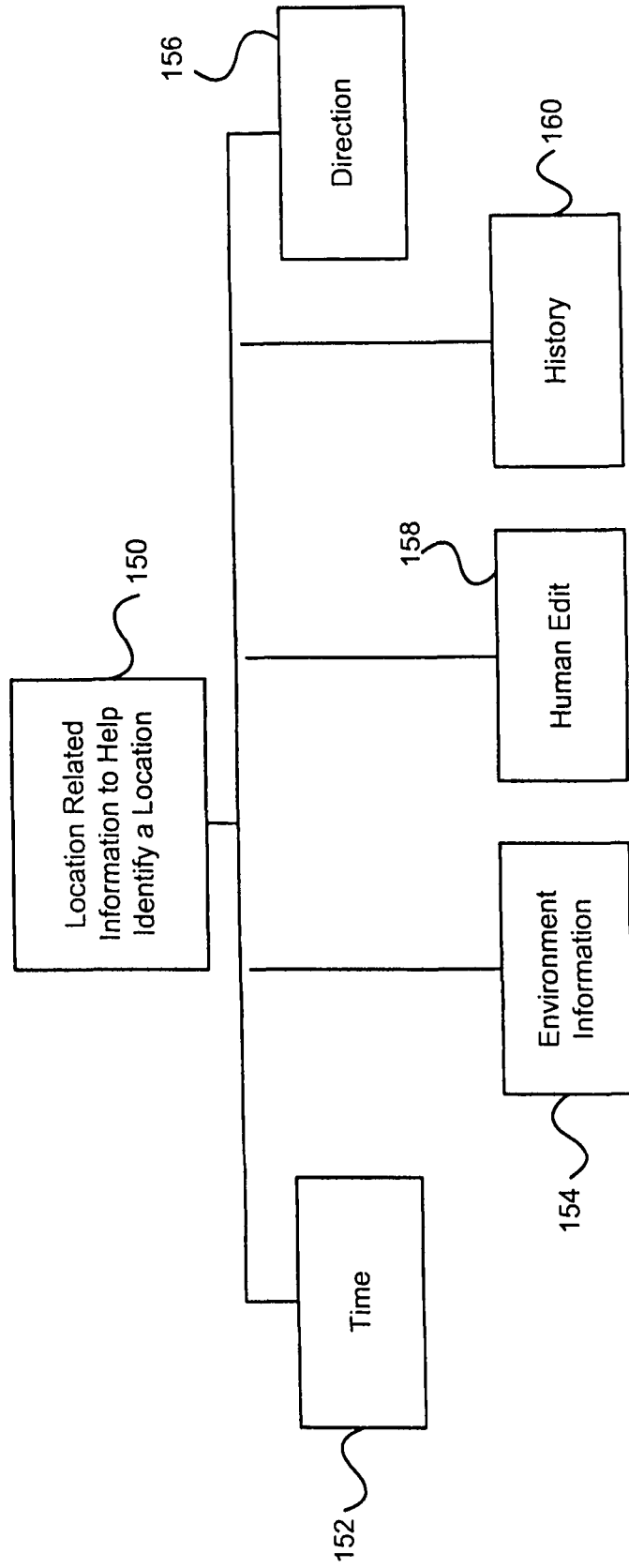

Figure 2

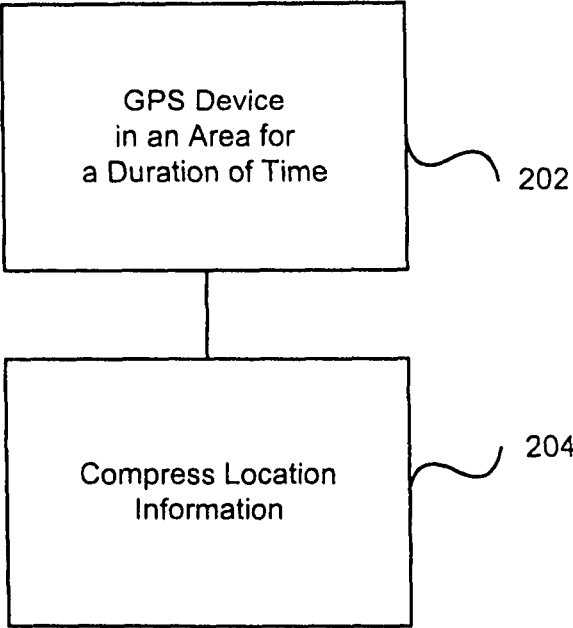

Figure 3(a)

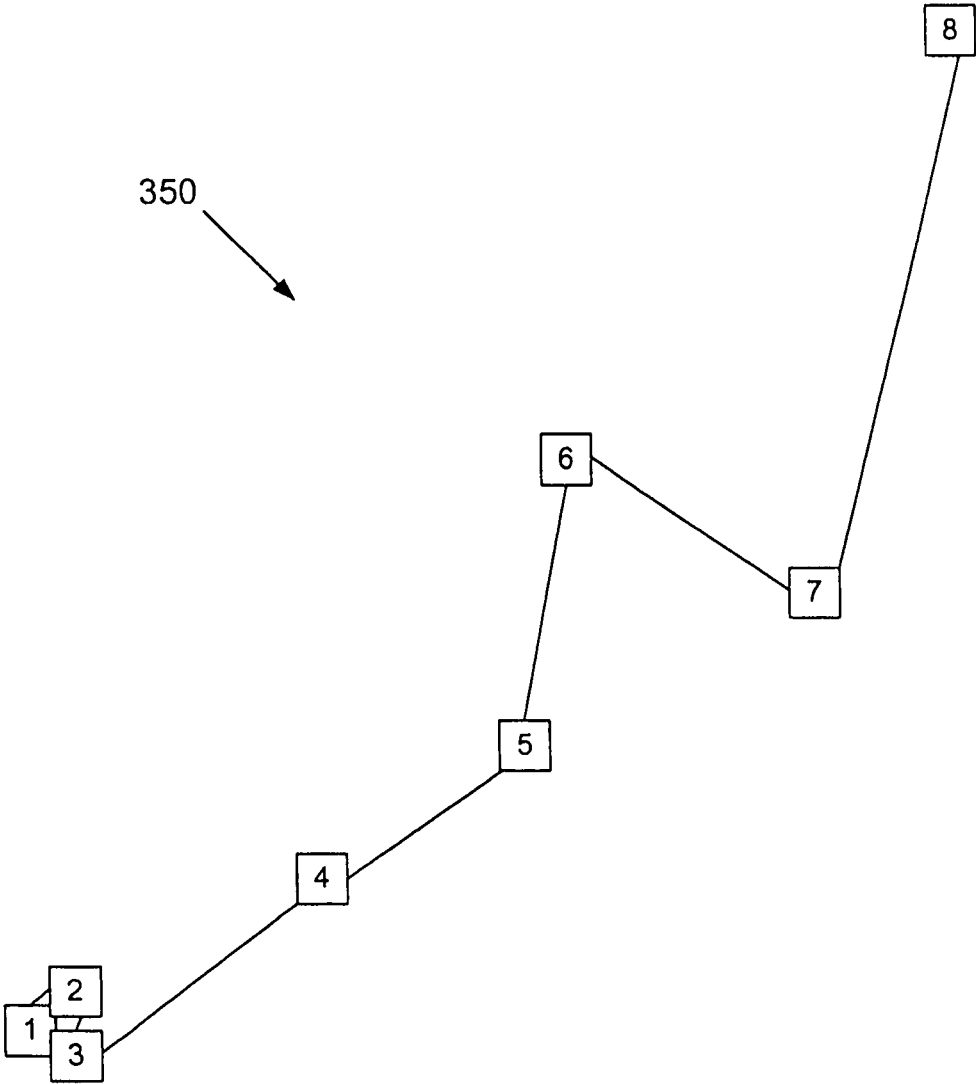

Figure 3(b)

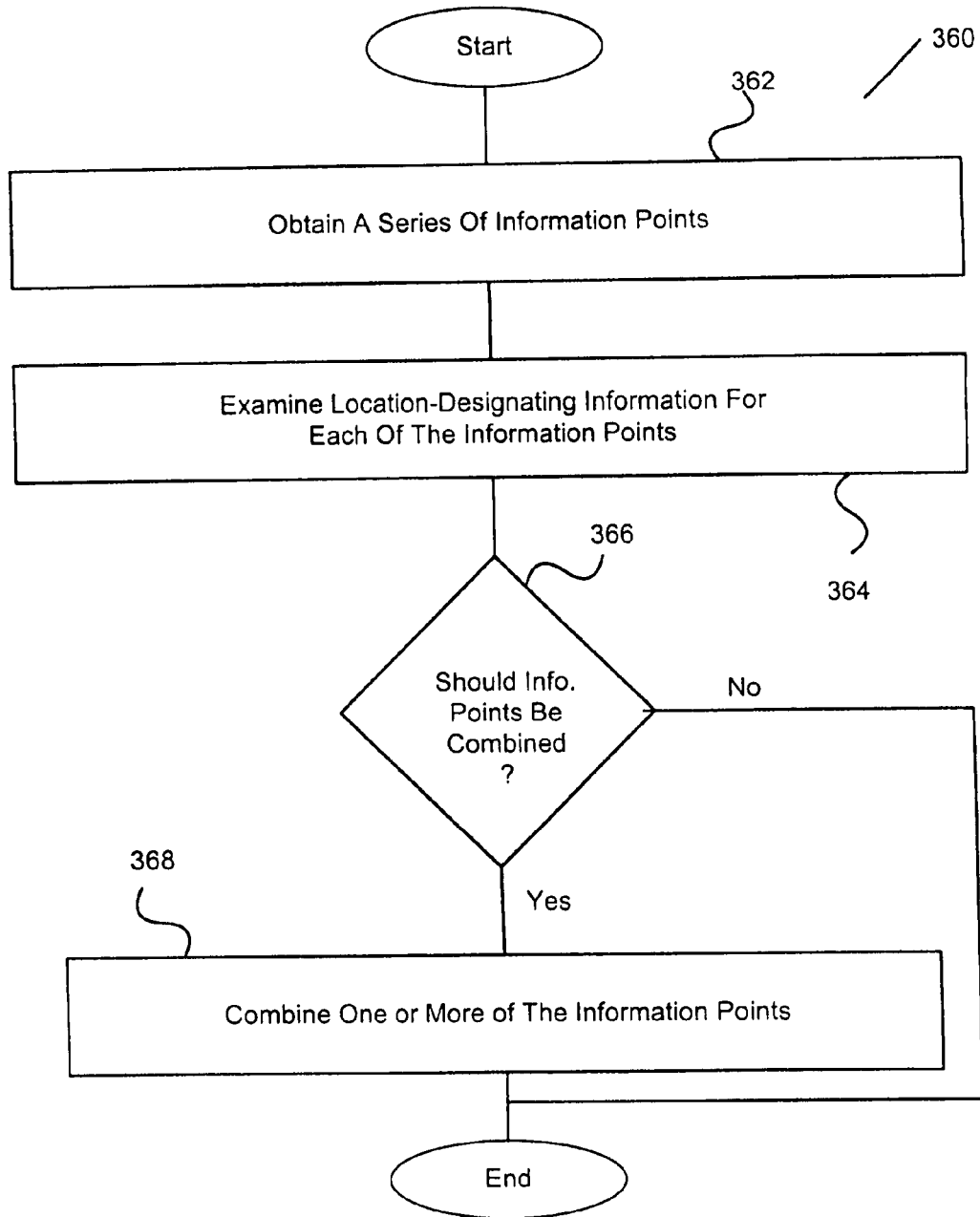

Figure 3(c)

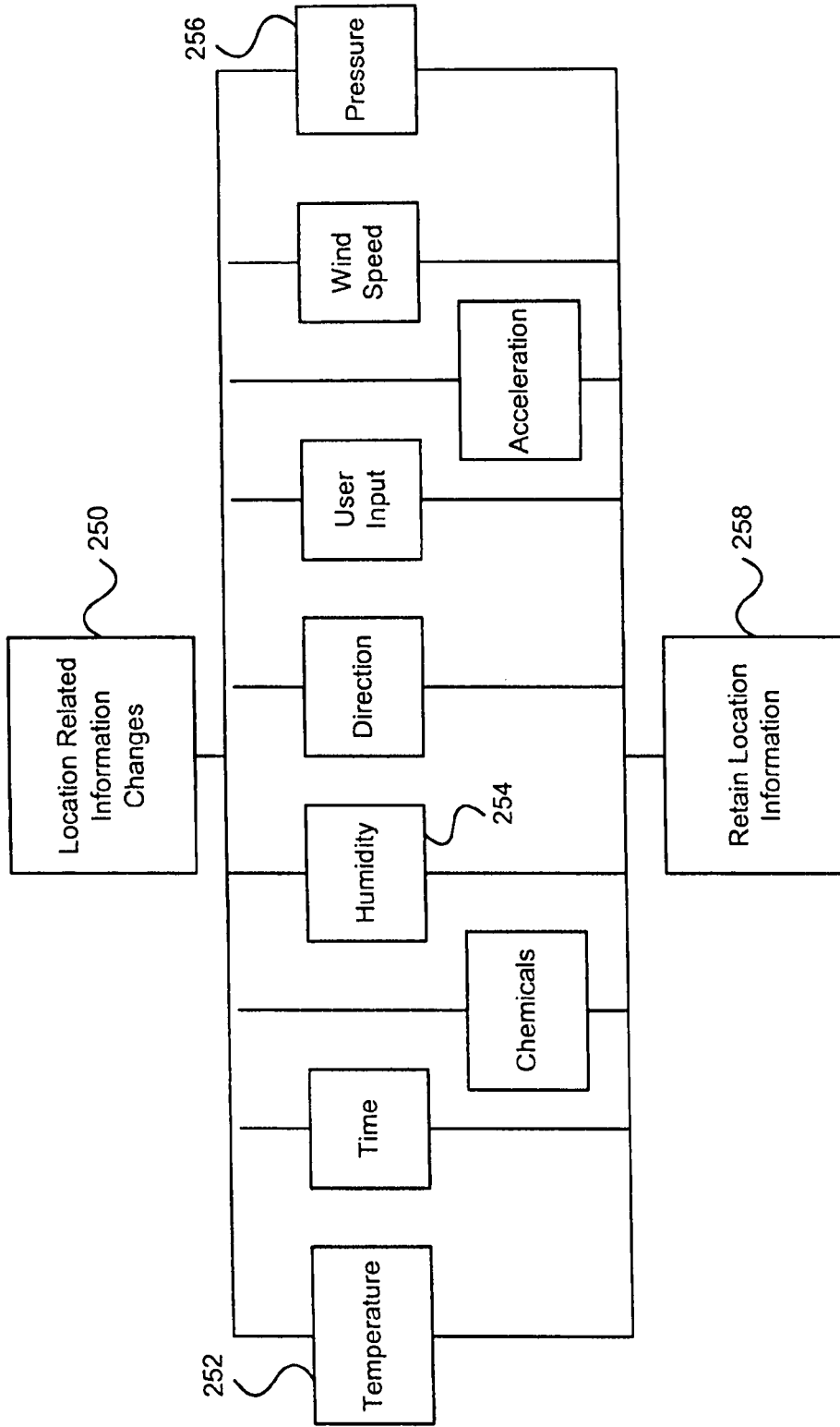

Figure 4

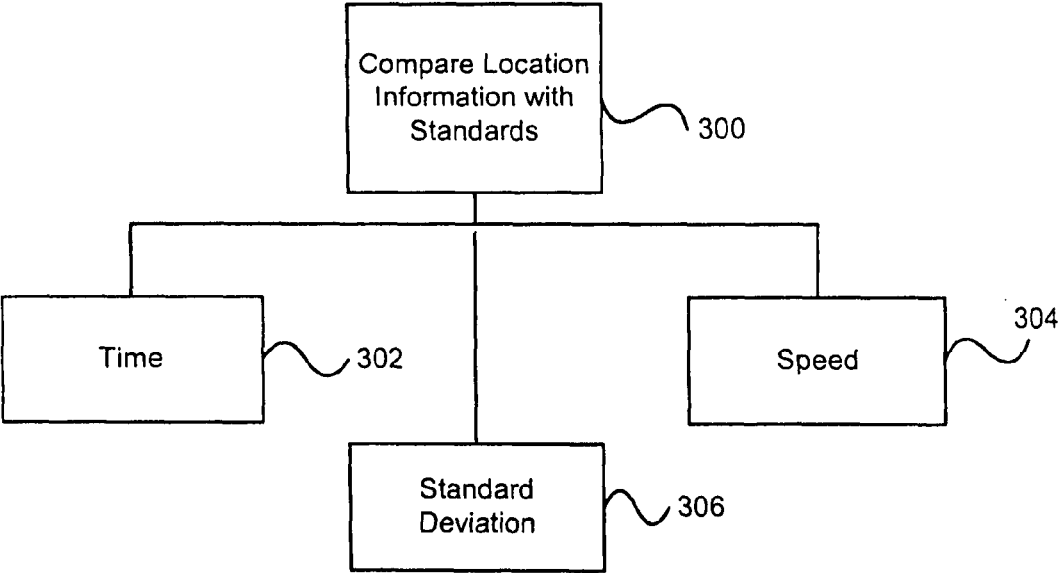

Figure 5

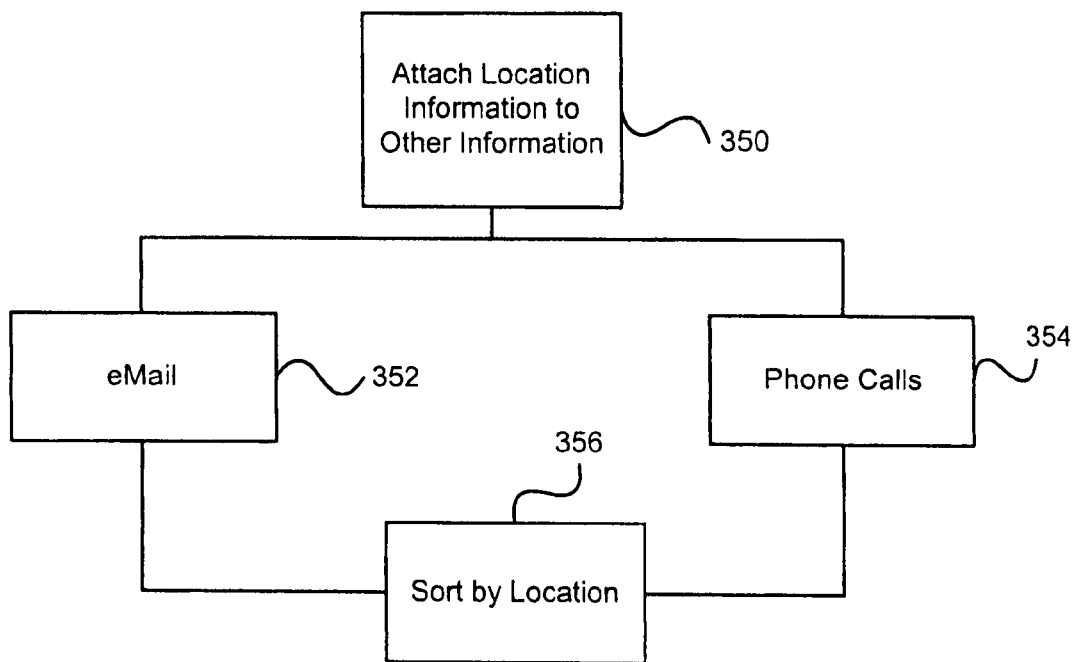

Figure 6

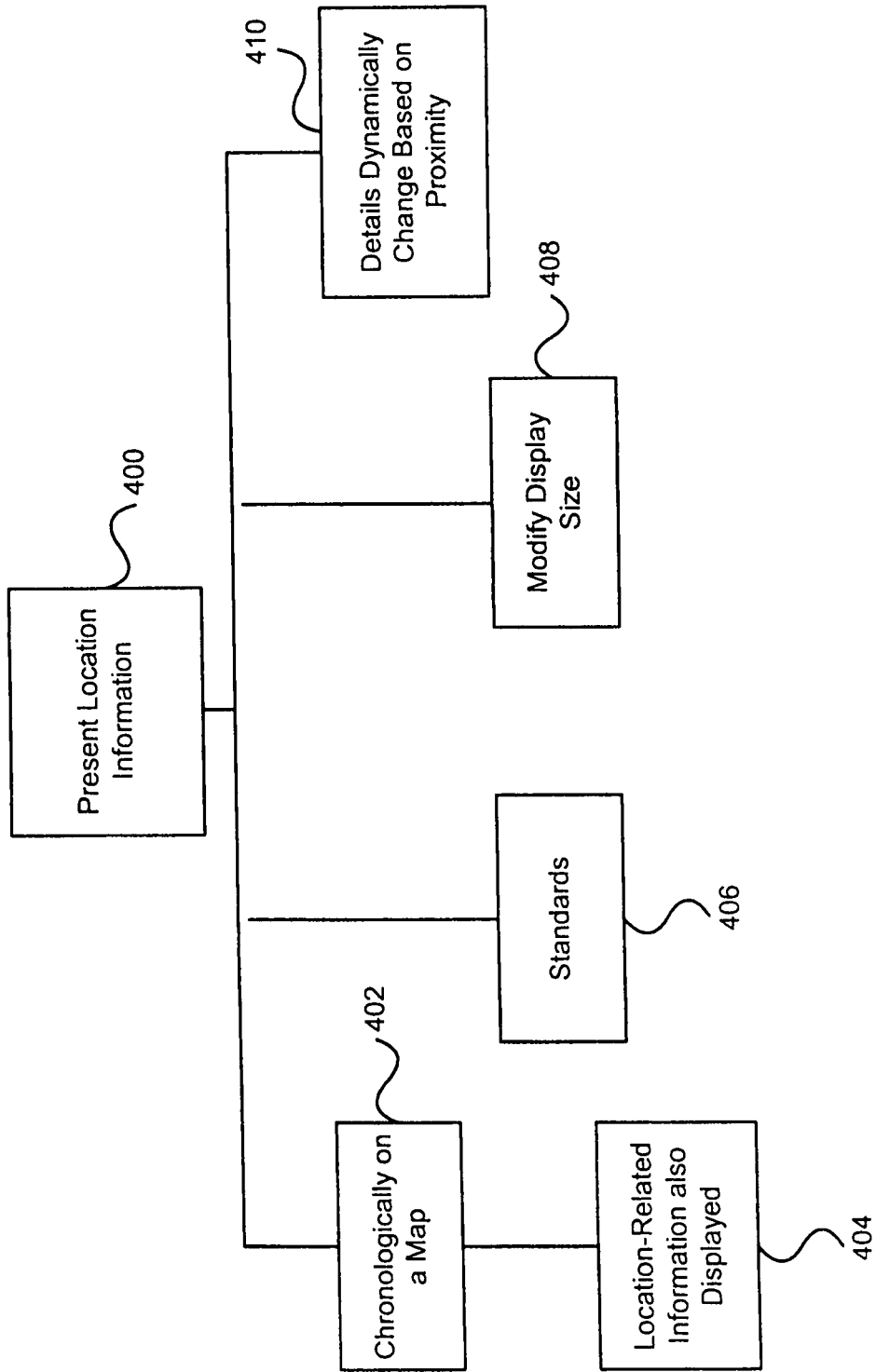

Figure 7

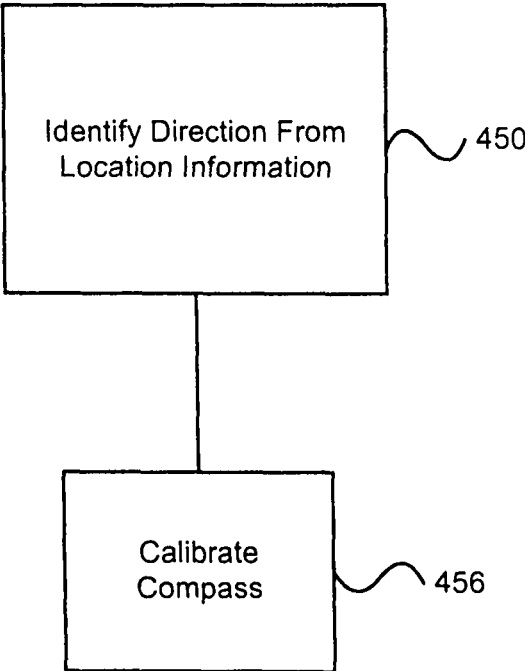

Figure 8

METHOD AND APPARATUS FOR LOCATION IDENTIFICATION

CROSS REFERENCE TO RELATED APPLICATIONS

This application is a continuation of U.S. patent application Ser. No. 10/397,472, filed Mar. 26, 2003, (now U.S. Pat. No. 7,218,938) and entitled "METHOD AND APPARATUS TO ANALYZE AND PRESENT LOCATION INFORMATION," which is hereby incorporated herein by reference, which, in turn, is a Continuation-In-Part of U.S. patent application Ser. No. 09/797,517, filed Feb. 28, 2001, (now U.S. Pat. No. 7,366,522) and entitled "METHOD AND SYSTEM FOR LOCATION TRACKING," which is hereby incorporated herein by reference, and which claims the benefit of U.S. Provisional Patent Application No. 60/185,480, filed Feb. 28, 2000, and entitled "METHOD AND SYSTEM FOR LOCATION TRACKING," which is hereby incorporated herein by reference.

The prior application Ser. No. 10/397,472 also claims benefit of: (i) U.S. Provisional Patent Application No. 60/444,198, filed Jan. 30, 2003, and entitled "SYSTEM, METHOD AND APPARATUS FOR ACQUIRING, PRESENTING, MONITORING, DELIVERING, MANAGING AND USING STATUS INFORMATION," which is hereby incorporated herein by reference; (ii) U.S. Provisional Patent Application No. 60/418,491, filed Oct. 15, 2002, and entitled "SYSTEM, METHOD AND APPARATUS FOR ACQUIRING, PRESENTING, MONITORING, DELIVERING, MANAGING AND USING STATUS INFORMATION," which is hereby incorporated herein by reference; (iii) U.S. Provisional Patent Application No. 60/404,645, filed Aug. 19, 2002, and entitled "SYSTEM, METHOD AND APPARATUS FOR ACQUIRING, PRESENTING, MONITORING, DELIVERING, MANAGING AND USING POSITION AND OTHER INFORMATION," which is hereby incorporated herein by reference; and (iv) U.S. Provisional Patent Application No. 60/375,998, filed Apr. 24, 2002, and entitled "SYSTEM, METHOD AND APPARATUS FOR ACQUIRING, PRESENTING, MANAGING AND USING POSITION INFORMATION," which is hereby incorporated herein by reference.

This application is also related to: (i) U.S. patent application Ser. No. 10/397,473, filed Mar. 26, 2003, now U.S. Pat. No. 6,975,941, and entitled "METHOD AND APPARATUS FOR INTELLIGENT ACQUISITION OF POSITION INFORMATION;" (ii) U.S. patent application Ser. No. 10/397,637, filed Mar. 26, 2003, (now U.S. Pat. No. 7,212,829) and entitled "METHOD AND SYSTEM FOR PROVIDING SHIPMENT TRACKING AND NOTIFICATIONS;" (iii) U.S. patent application Ser. No. 10/397,641, filed Mar. 26, 2003, and entitled "METHOD AND SYSTEM FOR PERSONALIZED MEDICAL MONITORING AND NOTIFICATIONS THEREFOR;" (iv) U.S. patent application Ser. No. 10/397,640, filed Mar. 26, 2003, (now U.S. Pat. No. 7,321,774) and entitled "INEXPENSIVE POSITION SENSING DEVICE;" (v) U.S. patent application Ser. No. 10/397,474, filed Mar. 26, 2003, (now U.S. Pat. No. 7,403,972) and entitled "METHOD AND SYSTEM FOR ENHANCED MESSAGING;" (vi) U.S. patent application Ser. No. 10/397,512, filed Mar. 26, 2003, and entitled "APPLICATIONS OF STATUS INFORMATION FOR INVENTORY MANAGEMENT."

BACKGROUND OF THE INVENTION

GPS (Global Positioning System) has been used extensively for navigation, positioning, and other research appli-

cations. It includes a group of satellites transmitting very precise signals. The nominal GPS Operational Constellation consists of 24 satellites that orbit the earth with 12-hour periods. These space vehicles (SV's) send radio signals that consist of time-tagged data bits marking the time of transmission, and information on the locations of the SV's, at the time they are transmitted. GPS receivers convert the received SV signals into the receivers' position. Four satellites are required to compute the four dimensions of X, Y, Z (position) and time. GPS receivers at precisely known reference locations can provide corrections and relative positioning data for receivers at other locations. Another use of GPS is to provide precise time and frequency standards through the use of precise clocks on-board the SV's.

For about two decades, GPS receivers have been used primarily in the outdoor environment. It is more challenging to use them indoors. The signal strengths from the SV's can be much reduced, such as by two orders of magnitude. A number of companies have been developing indoor GPS receivers. They are enticed by the US Federal Communications Commission's E911 telecommunication initiatives, which require wireless phone providers to locate any phone making a 911 emergency call.

The E911 initiative will greatly increase the proliferation of GPS devices. Telematics—the field of mobile services delivered wirelessly to in-vehicle devices—will further help GPS penetrate into different sectors of the society. One of the most visible manifestations of telematics is GPS-based navigation systems. They provide turn-by-turn directions and other information wirelessly to vehicle operators.

The amount and availability of GPS information will dramatically increase in the coming years. One challenge this will present is how to effectively use such information. There are needs for techniques to efficiently and intelligently analyze, process and present GPS information.

SUMMARY OF THE INVENTION

In general terms, the present invention pertains to the analysis of location information and/or the presentation of such information in an easy-to-digest manner.

Each piece of location information can include a piece of location-designating information and a piece of location-related information. Location-designating information is primarily for identifying location. In one embodiment, the location-designating information is longitudinal and latitudinal coordinates. Location-related information is information related to location-designating information. The location-designating information and the location-related information can be supplied by a mobile device. Multiple pieces of location-designating information can be retrieved and processed.

In one embodiment, each piece of location-designating information can be transformed into a label to help identify a location. To better identify locations, the process of transforming location-designating information into labels can use location-related information. For example, the mobile device is very close to the boundary of a theatre and a bookstore, and is about 40 feet from the ground level. One piece of location-related information is information on the environment. It indicates that the theatre has only one floor, while the bookstore has three floors. Since only the bookstore has more than one level and the mobile device is about 40 feet from the ground level, the mobile device is in the bookstore, not the theatre.

In another embodiment, the amount of location information can be reduced. An entire area can, for example, be represented by a single label. For analysis, all of the location-

designating information pertaining to a given area can be compressed (or consolidated) into one piece of location-designating information related to the label. This compression (or consolidation) process can be impacted or assisted by location-related information. For example, if a piece of location-related information changes by more than a pre-set value, the corresponding piece of location information will be retained.

To better present location information in an easy-to-digest manner, location information can be compared to standards. The standards can be related to time.

Presentation can be visually on a display with respect to a reference location. For example, the amount of detail displayed between the location of the mobile device and the reference location can dynamically change. This change can depend on the distance between the location of the mobile device and the reference location. Such an implementation is helpful particularly in situations when the size of the display is fixed.

The invention can be implemented in numerous ways, including as a method, system, device, or computer readable medium. Different embodiments of the invention will be discussed in subsequent sections.

Other aspects and advantages of the present invention will become apparent from the following detailed description, which, when taken in conjunction with the accompanying drawings, illustrates by way of examples the principles of the invention.

BRIEF DESCRIPTION OF THE DRAWINGS

FIG. 1(a) shows one embodiment of the present invention.

FIG. 1(b) is a flow diagram of label processing according to one embodiment of the invention.

FIG. 2 shows examples of location-related information to help identify a location in the present invention.

FIG. 3(a) shows one embodiment of compressing location information in the present invention.

FIG. 3(b) illustrates an exemplary path of movement of a location-designating device over a period of time.

FIG. 3(c) is a flow diagram of consolidation processing according to one embodiment of the invention.

FIG. 4 shows embodiments regarding retaining location information in the present information.

FIG. 5 shows embodiments of attaching location information to other information in the present invention.

FIG. 6 shows examples of standards compared to location information in the present information.

FIG. 7 shows embodiments related to the presentation of location information in the present invention.

FIG. 8 shows one embodiment of using location information to calibrate a compass in the present invention.

Same numerals in FIGS. 1-8 are assigned to similar elements in all the figures. Embodiments of the invention are discussed below with reference to FIGS. 1-8. However, those skilled in the art will readily appreciate that the detailed description given herein with respect to these figures is for explanatory purposes as the invention extends beyond these limited embodiments.

DETAILED DESCRIPTION OF THE INVENTION

The present invention pertains to the analysis of location information and/or the presentation of such information in an easy-to-digest manner. In one embodiment, there are two types of location information. One type is location-designating information, and the other is location-related information. Location-designating information is primarily for identifying

locations. The location-designating information can be longitudinal and latitudinal co-ordinates, or raw measurements (or pseudo-ranges) from GPS satellites. Location-related information is additional information that is related to a location. As will be explained in detail below, the location-designating information and the location-related information can be used in analyzing and presenting location information.

There can be a number of ways to generate location-related information. Some of the information can be automatically captured by additional sensors. Other can be entered by a person. For example, a user with a mobile device is in a bookstore. The mobile device is location-aware (e.g., GPS enabled) and can capture location-designating information. One type of location-aware mobile device is a mobile device that includes a GPS device (or GPS receiver). The user can add comments about the bookstore, or enter personal information and digitized pictures into his mobile device. The URL of the bookstore can be included. The user can be next to a house with a Wi-Fi network that allows the mobile device to get online. These can all be information related to the location, and can be automatically provided, or entered by the user. Such location-related information can be coupled to location-designating information, such as for identifying the location of the bookstore.

The company or organization at the location can broadcast certain information for attachment. For example, the bookstore can broadcast the URL of its website, or of special offers using the Bluetooth standards. Assume that the mobile device has Bluetooth technologies, and is Bluetooth enabled. With authorized reception of data, the mobile device can capture the broadcast signal and attach the information as a piece of location-related information.

Other sensors can be coupled to the mobile device to capture location-related information. For example, there can be a temperature sensor, a digital compass, a humidity sensor, a pressure sensor, a wind-speed sensor, an acceleration sensor or an accelerometer, a chemical sensor detecting chemical substance, a mechanical stress sensor, and/or other sensors to provide location-related information. The sensor data can be electronically coupled to corresponding location-designating information as location-related information.

Some of these sensors can be micro-electro-mechanical systems or micromachines. These sensors can be integrated with driving, controlling and signal processing electronics, and the integration can be monolithic.

The present invention can be implemented in a computing system. The computing system can be a standalone computing apparatus, a server computer, a client computer, a server computer with one or more client computers, or a computer in a peer-to-peer network. A client computer can be a thin-client. A client computer communicates to the server computer through a communication link or computer network. In one embodiment, a server computer, which can be software and/or hardware, is capable of responding to a communication initiated by a client computer with respect to an application. Similarly, a client computer, which can be software and/or hardware, is capable of initiating communication with a server computer with respect to an application. The computing system can also be a handheld computer, a personal digital assistant or a cellular phone.

The computing system can include a bus connecting a number of components, such as a processing unit, a main memory, an I/O controller, a peripheral controller, a graphics adapter, a circuit board and a network interface adapter. The I/O controller can be connected to components, such as a hard disk drive or a floppy disk drive. The peripheral controller can be connected to one or more peripheral components, such as

5

a keyboard or a pointing device. The graphics adapter can be connected to a monitor. The circuit board can be coupled to audio signals; and the network interface adapter can be connected to the network, which can be the Internet, an intranet, or other forms of networks. The processing unit can be an application specific chip. The computing system can include more than one processor, and can process information through parallel processing.

The present invention can also be implemented as a computer readable medium including at least computer program code for analyzing and/or presenting location information according to different embodiments described.

FIG. 1(a) shows a location resolution system **100** according to one embodiment of the present invention. The location

6

used by a person to query the information. As an example, one can search for the label, "Exploratorium". The following information can be retrieved in a table format:

Location	Exploratorium
Address	3601 Lyon Street, San Francisco, CA 94123
GPS co-ordinates	W 122° 26' 52.9" N 37° 48' 11.2"
Web site	www.exploratorium.edu
Miscellaneous information	...

A history of when the user was at the location can also be retrieved, as exemplified by the following table:

From	To	Date	On	Comments	Other Information
1:05 pm	3:02 pm	Feb. 2, 2002	Saturday	Lucas likes the place. Should visit more often.	A picture of Lucas we took outside: Lucas.tif
2:00 pm	3:10 pm	Mar. 2, 2002	Monday	Andy was fascinated by the anatomy of a human body.	A web site on human anatomy: http://www.bartleby.com/107/

resolution system **100** includes a retriever **102** to retrieve location information, and a transformer **104** to transform location-designating information into labels. Typically, location-designating information includes a set of numerical values. They can be raw measurements from GPS devices, or longitudinal and latitudinal coordinates, or other numerical representation of locations. It is not easy for a person to know where a location is just by looking at these numerical values.

In one embodiment of the present invention, labels are representations of locations that are easier to understand than the numerical representations. For example, instead of the set of longitudinal and latitudinal coordinates—W 122° 26' 52.9" and N 37° 48' 11.2"—its corresponding label can be the Exploratorium, the name of the place (e.g., business, home or other point of interest) with that set of coordinates. A label can be the physical address of the place. In the case of the Exploratorium, it is 3601 Lyon Street, San Francisco, Calif. 94123. Labels can help people better identify a place than a set of numbers.

In transforming location-designating information into labels, the transformer can access a location database. In one embodiment, a previously-created database maps location-designating information, such as longitudinal and latitudinal co-ordinates, to their corresponding labels. The location database can be in the mobile device or in a remote server wirelessly coupled to the mobile device. Access to the location database can be restricted through password protection or other techniques.

The system identifies the labels corresponding to location-designating information, and retrieves such information from the database. The system can be in the mobile device or it can be in a remote server. Labels can then replace the location-designating information, and can couple to the corresponding location-related information. For example, the location-related information can be stored along with the labels in the mobile device, such as a personal-digital assistant. In another example, the location-related information is stored along with the labels in a remote computer.

In one embodiment, the location information can then be queried by a query processor. The query processor can be

The information can be queried in different ways. For example, one can find out where the user was on Mar. 2, 2002 at 3 pm through standard searching algorithms.

FIG. 1(b) is a flow diagram of label processing **120** according to one embodiment of the present invention. The process **120** can be performed on a server or a client.

The label processing **120** initially obtains **122** location coordinates provided by the mobile device. The mobile device is location aware and thus typically captures location coordinates. Additionally, location-related information is obtained **124**. The location-related information is associated with the location coordinates. The location-related information can also be provided by the mobile device. For example, the mobile device can include one or more sensors or input devices to acquire the location-related information. Then a location label can be acquired **126** for the location coordinates based on the location coordinates and the location related information.

Through use of both the location coordinates and the location-related information, more accurate location labels are able to be acquired. The location labels are more descriptive of actual location and are more user-friendly than the location coordinates. The acquisition of location labels can also be considered as a transformation of location coordinates into location labels.

In many situations, it may not be clear where a location corresponding to a piece of location-designating information really is. The resolution of GPS devices can have errors of 15 meters or more. Based on the location-designating information, the user may be at one or more locations. For example, a multi-story bookstore is directly adjacent to a single-story theatre. The user with a mobile device, such as a cell phone having a GPS device, might be standing at a window of the bookstore, with the window facing the theatre. The cell phone can transmit the location-designating information or the corresponding labels to a remote system of the invention. Based on the accuracy of the GPS device, the system is aware that the user is in the vicinity of the bookstore and the theatre. But the system may not be able to pinpoint whether the user is in the bookstore or the theatre.

FIG. 2 shows examples of location-related information to help identify a location. One approach is to use a piece of information regarding the environment **154** where the person is located. Location-designating information from a GPS device can identify not only the longitudinal and latitudinal coordinates, but also the elevation. Assume the elevation coordinate indicates that the person is about 40 feet from the ground level. Based on information regarding the environment, only the bookstore has more than one level, the user is in the bookstore. Thus, depending on the location-related information of the bookstore having multi-story, the transformer identifies the bookstore as the correct location. In this example, the name of the bookstore can be the transformed label.

Another approach to better define a location is to use the time **152** information provided by GPS. For example, at time x , the user is close to the junction of the theatre and the bookstore. Assume at time $(x+10)$ seconds, the person has moved to the center of the bookstore. Based on this second piece of information, the system infers that at time x , the user was in the bookstore, not the theatre. In this approach, location information at different time frames are evaluated or collected to better define a location.

Yet another approach to better define a location is to use direction **156** information. Again, assume that the user at the junction of the theatre and the bookstore. One rule can be that while the user is at the junction, the user is in the bookstore if he is moving in the direction of the bookstore. One approach to measure direction depends on taking two pieces of location information at two different time frames, such as 5 seconds apart. Based on the second location, the direction of travel at the first location can be identified.

Instead of using location information at different time frames, direction **156** can be provided by a direction sensor (e.g., digital compass) in the mobile device (e.g., cell phone). Such direction information can be coupled to the location-designating information, and transmitted to another computing apparatus to have the location information analyzed. In another embodiment, the information is not transmitted, but is analyzed in the mobile device. Based on the analysis, the mobile device can display the label on its screen.

It could also be up to the user **158** to better define the location. The mobile device can identify a few choices for the user to select. For example, a display on the mobile device can show the options of both the bookstore and the theatre. The user can select one of them by using a pointing device on a digitizer, a scrolling function to allow selection, or a voice recognition system, where the user can verbally make the selection.

Also, a history **160** of prior locations or frequently visited locations could be used to better define the location. For example, based on the history, the user visits a bookstore at least ten times more than its adjacent theatre. Then, if the location-designating information indicates that the user can be in the bookstore or in its adjacent theatre, one rule will assume the user to be in the bookstore. The history **160** can also be used to make processing more efficient. For example, if the history **160** indicates that the current location is same or proximate to a prior location, the current location can be deemed to be the same as the prior location, typically with minimal processing.

The amount of location information can be quite large. In one embodiment, a system of the invention also includes a compressor to compress the amount of location information.

FIG. 3(a) shows one embodiment of compressing location information according to one embodiment of the present invention. In this approach, the user with a mobile device coupled to a GPS device is in an area for a duration of time **202**. During this time period, the device collects sets of location information, each at a specific time. Through analysis, it has been determined that the device is in the same area during this time period. For example, every set of longitudinal and latitudinal coordinates is mapped to the same label. The compressor will compress all of the location-designating information **204** to one set, indicating the device being in the area during that time period.

In one approach, the compressor retrieves sets of longitudinal and latitudinal co-ordinates of the GPS device, and transforms them to labels. As the compressor transforms a set of longitudinal and latitudinal coordinates of a piece of location information into a label, it also compares that label with the label from the immediately prior time. If the two labels are the same, the compressor will not store the location information of that label for additional analysis. In one embodiment, additional pieces of location-designating information in the same zone as the immediately earlier piece will not be further analyzed. If two labels are the same, they can be considered to be in the same zone; if two labels are within a certain pre-determined distance from one another, they can be considered as to be in the same zone; or if the distance between the two sets is less than a pre-set value, again, they can be considered as to be in the same zone.

In another approach, if the distance between two sets of location-designating information is less than a pre-set value (e.g., predetermined value, tolerance, range or offset), the compressor will not store the second piece of location information, which is the location information at a later time. This process can continue. For example, the compressor can determine the distance between a third set and the first set to be still less than the pre-set value. Again, the third set of location information need not be stored.

Under certain conditions, even if the device has not moved out of an area designated by a label, there might still be changes in certain information, warranting the keeping of location information, or at least some portion of it. For example, the user is transporting humidity-sensitive chemicals within a certain area of the city, and suddenly it rains heavily, significantly changing the humidity. It might be desirable to be aware of the location and time when such changes occurred.

FIG. 3(b) illustrates an exemplary path **350** of movement of a location-designating device over a period of time. Namely, the exemplary path **350** is composed of a sequence of eight (8) locations where location-designating information and location-related information were captured. A sequence of locations of a path can be processed to compress what would otherwise be large and unmanageable amounts of information. Once compressed, the quantity of data is reduced and the information is more user-friendly. Table 1 provided below illustrates exemplary location-designating information and location-related information that have been captured for the eight (8) locations shown in FIG. 3(b).

TABLE 1

	1	2	3	4	5	6	7	8
Label	—	—	—	—	—	—	—	—
Long.	X1	X2	X3	X4	X5	X6	X7	X8
Lat.	Y1	Y2	Y2	Y4	Y5	Y6	Y7	Y8
Time	1:00 pm	1:15 pm	1:30 pm	1:45 pm	2:00 pm	2:15 pm	2:30 pm	2:45 pm
Date	Jan. 1, 2002	Jan. 1, 2002	Jan. 1, 2002	Jan. 1, 2002	Jan. 1, 2002	Jan. 1, 2002	Jan. 1, 2002	Jan. 1, 2002
Temp.	90	90	90	89	89	88	88	87
Other	—	—	—	—	—	—	—	—

The data stored in the Table 1 can represent the raw data provided by the location-designating device. At this point, in this embodiment, the descriptive labels are not known, but the longitude and latitude coordinates are known (e.g., provided by GPS device). The date and time can be provided by a GPS device or by a clock within the location-designating device. Further, other sensors can provide various other location-related information. In this example, the other location-related information includes at least temperature and an “other” category to represent one or more other pieces of information.

The data stored in Table 1 can then be compressed to a more compact and manageable form. Table 2 provided below illustrates exemplary compression processing on the data within Table 1.

TABLE 2

	point					
	1	2	3	4	5	6
Label	Exploratorium, SF	RT. 101, So. SF	Rt. 101, Menlo Park	Rt. 101, Mountain View, CA	7Eleven, Saratoga, CA	Home, Saratoga, CA
Long.	—	—	—	—	—	—
Lat.	—	—	—	—	—	—
Time	1:00-1:30 pm	1:45 pm	2:00 pm	2:15 pm	2:30 pm	2:45 pm
Date	Jan. 1, 2002	Jan. 1, 2002	Jan. 1, 2002	Jan. 1, 2002	Jan. 1, 2002	Jan. 1, 2002
Temp.	90	89	89	88	88	87
Other	—	—	—	—	—	—

As shown, the locations 1-3 in Table 1, along the path as shown in FIG. 3(b), are very close to one another and such is reflected by the longitude and latitude coordinates for these locations. Hence, by examining the first 3 locations, the compressor determines that these location are to be treated as the same location. Here, based on information from a location database, assume that the location is the Exploratorium in San Francisco, Calif. In effect, these location points can collapse into a single location point. However, any difference between the individual location points (such as their location-related information) can be preserved if desired. The other locations 4-8 in Table 1 (now locations 2-6 in Table 2) are deemed to represent different locations and are individually processed for labels. Once a label is identified, the longitude and latitude coordinates can be eliminated if desired.

The exemplary compression processing shown with Table 2 is only one simplified example; hence, it should be understood that compression processing can be performed in a wide variety of different ways.

FIG. 3(c) is a flow diagram of consolidation processing according to one embodiment of the invention. The consolidation processing can be performed on a server or a client or a computing device in a peer-to-peer network.

The consolidation processing initially obtains a series of information points. The series can be ordered based on the time each point is acquired. The series of information

points are, for example, obtained from storage or directly from a mobile device. Each of the information points typically has location-designating information and location-related information. Next, the location-designating information for each of the information points is examined. A decision then determines whether any of the information points should be combined. Here, in this embodiment, the decision is based on the location-designation information for the information points. For example, if two consecutive location-designation information are substantially matched, the two information points should be combined. One rule regarding matching can be that if two consecutive location-designation information are close to each other, such as within 5 meters apart, they are considered as substantially

matched. Another rule can be that if two consecutive pieces of location-designation information are in the same area, point of interest or label, they are considered substantially matched.

In another embodiment, the decision can be based on not only the location-designation information but also the location-related information. If two consecutive pieces of location-designation information and location-related information are substantially matched, the two information points should be combined. Different thresholds can be set to determine if location-related information from different points are substantially matched. For example, the location-related information is the temperature of the environment. One rule can be that if the temperatures of two consecutive points are close to each other, such as setting the threshold to be 3 degrees, the location-related information from the two points are considered substantially matched. Another rule can be that if the difference between two consecutive pieces of location-related information is less than a certain percent, such as 3%, of the value of the first piece of location-related information, the two pieces of location-related information are considered substantially matched.

In any case, when the decision determines that some of the information points should be combined, the two or more of the information points are combined. On the other hand, the information points are not combined when the decision determines that these information points should not be combined.

Once information points are combined, the resulting information point can be a normal information point (with perhaps additional data) or a compound information point (retaining some or all of the data of the information points being combined). For example, information under each of the locations in Table 1 can be considered information under an information point. Information points 1-3 under Table 1 are combined into information point 1 under Table 2. The new information 1 can be considered a compound information point because it retains some of the time information of points combined. In any case, the combining of information points operates to consolidate the series of information points such that the data is more compact and/or better organized.

FIG. 4 shows examples of location-related information 250 regarding consolidation. For example, the location-related information can include temperature 252, humidity 254, direction, wind speed, time, user-input, chemicals, acceleration and pressure 256. Some of the location-related information is information regarding the environment where the location-designating device is located, such as temperature, humidity, wind speed, chemicals, and atmospheric pressure, tire pressure or other types of pressures. Other of the location-related information can pertain to the location-designating device itself, such as the acceleration of the device, or the pressure being asserted on the device. Examples of other sensors to provide related information include carbon monoxide detectors, liquid sensors, metal detectors, color sensors, scent sensors, light sensors, pattern sensors, tactile sensors, sound sensors, motion detectors, smoke sensors, particle sensors and radiation detectors, such as infrared detectors. Related information can be captured by the corresponding sensors, with the related-information coupled to location-designating information. The coupling can be achieved wirelessly. For example, a chemical sensor attached to a package can transmit the amount of certain gaseous chemicals through Bluetooth or WiFi technologies to the location-designating device, which is also coupled to the package.

The following provides additional examples of location-related information that impact consolidation or compression, and are used in determining to retain location information 256. An administrator (e.g., user) can set a threshold for a location-related information. For example, a rule the administrator sets for the compressor can be: From position A to position B, if the temperature at any position changes by more than x degrees from that at point A, keep the location information at that position. Another rule can be: During any one-hour period, keep the location information where the humidity changes by, such as, more than 50% from that at the beginning of that hour. A third rule for a threshold can be that if time has elapsed by, such as, 1 hour, from the time when a piece of location information has been retained, keep the new location information. Another rule for a threshold can be that if a certain type of chemical exceeds a certain amount, keep the location information. Yet another rule can be that if a user has entered information at a specific location, keep the location information. In this case, the threshold can be set, for example, to zero or one character difference in user entry. If there is any changes in user entry, such as from not entering anything to inputting something, or to inputting something different, the location information at that position can be kept.

Location information collected can be attached to other information. FIG. 6 shows a few embodiments of attaching certain location information 350 to other information. For example, labels can be attached to emails 352, phone calls 354, or other types of messages, when they are sent. Then, received emails not only indicate who sent them, they would also indicate the locations from where they were sent. Emails

and phone calls can then be sorted 356 based on locations. In one embodiment, the sorting can be alphabetical, such as through the labels.

To help users digest location information, sometimes it is advantageous to compare them to standards. In one embodiment, a system of the invention includes a comparator for comparing location information with standards. FIG. 6 shows examples of standards for comparison. In one example, a label represents a five-mile strip (portion) of a specific highway. The average amount of time T 302 to travel through that five-mile strip is known. The user drives his car through the strip. The time he enters and exits that label is stored, and their difference is compared to T. If the difference is more than a pre-set threshold, a notification can be sent to the user. Similarly, the standard can be the speed 304 of a typical car traveling through that strip.

In another example, the amount of time can be that of an item on the shelf of a company, such as a supermarket. The location of that item is monitored.

Standard deviations, 306, can also be tracked. This can be the standard deviation of the travel time of a specific car through the strip during the last two months. If the standard deviation is more than a pre-set threshold, the driver can be notified.

FIG. 7 shows embodiments related to the presentation 400 of location information. In one embodiment, location information can be presented chronologically on a map 402. Location-related information can be coupled to the corresponding labels and displayed on the map 404. For example, a piano is shipped from San Francisco to Tokyo. The map can show chronologically where the piano is at different times. Next to the shipping path, there can be two other line graphs, one showing the humidity, and the other showing the temperature at the corresponding location and time. The location-related information can also be coupled to the corresponding labels and displayed as a link or visual indicator which is selectable to cause the location-related information to be displayed.

The presentation can be in a tabulated format, such as in a spreadsheet. Presentation can be in graphical formats, such as in bar charts or pie charts, in two or more dimensions.

Location information where a mobile device enters and exits a label can be presented. Location information where there are changes exceeding thresholds in location-related information can also be shown.

The display of location-related information can be through clickable icons. 404 on a web site. For example, the user was in the Exploratorium at 4 pm. A small icon representing the Exploratorium can be displayed next to the location of the chart indicating where the user was at 4 pm. Clicking the icon would lead one to the web site of the Exploratorium.

Location information can be displayed with their standards 406. For example, a display can show the speed of a car as a function of location. Next to that, there can be another line showing standard speeds at the different locations.

In one embodiment, the display size can be modified 408. For example, the screen on a handheld device can be small. When the user is in a car, the user can dock the device, which can electronically couple the device to a larger screen in the car for viewing.

In another embodiment, the locations of a GPS device are displayed with respect to a specific location. The amount of details displayed between the locations of the GPS device and the specific location can dynamically change 410. This change can depend on the distances between the locations of the GPS device and the specific location. The amount of details can be defined as the density of the points of interest

shown in an area. Points of interest can include the name of a street, the name of a park or other designations.

As an example, the number of labels shown between the locations of the GPS device and the specific location depends on the distances between the locations and the specific location. If the GPS device is very far away from the specific location, there will be many labels in between. With the display size being fixed, if all of the labels are shown, the display can be cluttered. So, very few labels should be shown. However, as the GPS device approaches the specific location, the ratio of labels being shown and the total number of labels between the locations increases. This can be done dynamically, depending on the separation distance. One way is to fix the number of labels to be shown on the display to be fewer than a predetermined number (e.g., 10). If there are more than the predetermined number of labels to be shown, certain labels can be skipped, such as every other one. If there are 100 labels, and only 10 can be shown, then every 10th label can be selected to be shown. In this example, even a label is in between the GPS device and the specific location, the label may not be displayed. In other words, whether a label between the location of the GPS device and the specific location is displayed or not depends on the distance between the location of the GPS device and the specific location. Note that whether a label is displayed or not can also depend on user preferences. The user can require a label to be shown if the label is between the location of the GPS device and the specific location.

In another example, the specific location is the location of another GPS device. That specific location can change as the other GPS device is moved.

Location information can be dynamically generated. As the GPS device moves, location information can be generated. So the presentation of location information can change as a function of time.

In a number of embodiments, a label identifies locations that are two-dimensional. However, a label can identify a three-dimensional volume. In other words, elevation coordinates can be included.

The present invention has described one or more GPS devices as location-designating devices to identify a location. However, the present invention is not limited to using one or more GPS devices to identify a location. In certain situations, other wireless or mobile devices can also serve as location-designating devices, such as devices based on GSM technologies or Wi-Fi technologies. Through the techniques of triangulation, these devices can also designate a location. Such triangulation techniques should be known to those skilled in the art.

Note that the process of transforming location coordinates into labels and the process of using additional information to help identify a location can be performed by two separate entities. In other words, a corporation can be responsible to transform location coordinates into labels. Then another corporation is responsible to clarify the location corresponding to a piece of location-designating information, using, for example, location-related information.

A number of embodiments have been described where the process of transforming location coordinates into labels or the process of compressing depends on a piece of location-related information. Note that such processes can depend on more than one piece of location-related information. Also, the multiple pieces of location-related information can be of different types. For example, the process of transforming can depend on time and a piece of information regarding the environment.

As described above, since multiple pieces of location information from a GPS device can identify direction **450**, the GPS device can be used to calibrate a digital compass, **452**, as illustrated in FIG. 8. A GPS device can provide multiple location information as a function of time. If the person carrying the device is traveling along a certain constant direction, the multiple location information will be able to identify that direction. The direction information can then be used to calibrate a digital compass, as long as the compass is attached to, or traveling in the same direction as, the GPS device.

The above-described systems, devices, methods and processes can be used together with other aspects of a monitoring system, including the various aspects described in: (i) U.S. Provisional Patent Application No. 60/444,198, filed Jan. 30, 2003, and entitled "SYSTEM, METHOD AND APPARATUS FOR ACQUIRING, PRESENTING, MONITORING, DELIVERING, MANAGING AND USING STATUS INFORMATION," which is hereby incorporated herein by reference; (ii) U.S. Provisional Patent Application No. 60/418,491, filed Oct. 15, 2002, and entitled "SYSTEM, METHOD AND APPARATUS FOR ACQUIRING, PRESENTING, MONITORING, DELIVERING, MANAGING AND USING STATUS INFORMATION," which is hereby incorporated herein by reference; (iii) U.S. Provisional Patent Application No. 60/404,645, filed Aug. 19, 2002, and entitled "SYSTEM, METHOD AND APPARATUS FOR ACQUIRING, PRESENTING, MONITORING, DELIVERING, MANAGING AND USING POSITION AND OTHER INFORMATION," which is hereby incorporated herein by reference; and (iv) U.S. Provisional Patent Application No. 60/375,998, filed Apr. 24, 2002, and entitled "SYSTEM, METHOD AND APPARATUS FOR ACQUIRING, PRESENTING, MONITORING, DELIVERING, MANAGING AND USING POSITION INFORMATION," which is hereby incorporated herein by reference.

The various embodiments, implementations, features and aspects of the invention noted above (including those incorporated by reference) can be combined in various ways or used separately. Those skilled in the art will understand from the description that the invention can be equally applied to or used in other various different settings with respect to various combinations, embodiments, implementations or features provided in the description herein.

The invention can be implemented in software, hardware or a combination of hardware and software. The invention, or at least certain software portions of the invention, can also be embodied as computer readable code on a computer readable medium. The computer readable medium is any data storage device that can store data which can thereafter be read by a computer system. Examples of the computer readable medium include read-only memory, random-access memory, CD-ROMs, magnetic tape, optical data storage devices, and carrier waves. The computer readable medium can also be distributed over network-coupled computer systems so that the computer readable code is stored and executed in a distributed fashion.

Other embodiments of the invention will be apparent to those skilled in the art from a consideration of this specification or practice of the invention disclosed herein. It is intended that the specification and examples be considered as exemplary only, with the true scope and spirit of the invention being indicated by the following claims.

The invention claimed is:

1. A computer-implemented method to identify the location of a location-aware mobile device for a user, the mobile device being configured to be operable as at least a wireless communication device allowing a person to wirelessly send and receive messages with others, the method comprising:

15

retrieving GPS location-designating information acquired by the location-aware mobile device using GPS signals, which are available at the location of the mobile device; retrieving location-related information that is not based on GPS signals, but is based at least on a sensor in the mobile device, the location-related information being available at the location of the mobile device; and identifying the location of the mobile device based on both the GPS location-designating information and the location-related information,

wherein the GPS location-designating information can approximately identify the location of the mobile device, and

wherein the location of the mobile device is more accurately or narrowly identified based on at least the location-related information.

2. A computer-implemented method as recited in claim 1 further comprising transforming the identified location into a location label, wherein the location label pertains to a name used by a plurality of people to designate the location.

3. A computer-implemented method as recited in claim 1, wherein the mobile device is a mobile phone.

4. A computer-implemented method as recited in claim 1, wherein the method is performed by the mobile device.

5. A computer-implemented method as recited in claim 1, wherein the method is performed by a computing device at least based on information wirelessly received from the mobile device.

6. A computer-implemented method as recited in claim 5, wherein the information wirelessly received is received at least via a Wi-Fi network.

7. A computer-implemented method as recited in claim 2, wherein the label is stored in a storage device, and wherein the method further comprises electronically searching the storage device to identify and retrieve the label.

8. A computer-implemented method as recited in claim 2, wherein the label is a point of interest.

9. A computer-implemented method as recited in claim 1, wherein the location-related information depends on another location-designating information identifying another location of the mobile device, the another location-designating information being acquired by the mobile device.

10. A computer-implemented method as recited in claim 1, wherein the location-related information includes direction information.

11. A computer-implemented method as recited in claim 1, wherein the location-related information includes information entered by a person.

12. A computer-implemented method as recited in claim 1, wherein the location-related information includes information regarding a plurality of prior locations of the mobile device.

13. A computer-implemented method as recited in claim 1, wherein the location-related information includes a piece of information regarding the environment where the mobile device is located.

14. A computer-implemented method as recited in claim 1, wherein the GPS signals are from at least four pieces of information from satellites to identify position.

15. A computer-implemented method as recited in claim 14, wherein the location-related information comprises another location-designating information that is based on Wi-Fi technologies applying triangulation techniques.

16

16. A computer-implemented method as recited in claim 14, wherein the location-related information comprises another location-designating information that depends on GSM technologies.

17. A computing device to identify the location of a location-aware mobile device for a user, the mobile device being configured to be operable as at least a wireless communication device allowing a person to wirelessly send and receive messages with others, the computing device comprising:

a retriever configured to retrieve GPS location-designating information acquired by the location-aware mobile device using GPS signals, which are available at the location of the mobile device, wherein the retriever is also configured to retrieve location-related information; and

an identifier configured to identify the location of the mobile device based on both the GPS location-designating information and the location-related information;

wherein the GPS location-designating information can approximately identify the location of the mobile device,

wherein the location of the mobile device is more accurately or narrowly identified based on at least the location-related information,

wherein the location-related information depends on Wi-Fi technologies to help identify location,

wherein the location-related information is available at the location of the mobile device, and

wherein the computing device is able to be coupled to the mobile device.

18. A computing device as recited in claim 17 further comprising a transformer configured to transform the identified location into a location label, wherein the location label pertains to a name used by a plurality of people to designate the location.

19. A computing device as recited in claim 18 further comprising:

a storage device configured to store the label; and

a query processor configured to search the storage device to identify and retrieve the label.

20. A computing device as recited in claim 17, wherein the location-related information depends on another location-designating information identifying another location of the mobile device.

21. A computing device as recited in claim 17, wherein the mobile device is a mobile phone.

22. A computing device as recited in claim 17, wherein the GPS signals are based on information from at least four satellites.

23. A computing device as recited in claim 22, wherein the location-related information comprises another location-designating information that is based on Wi-Fi technologies applying triangulation techniques.

24. A computing device as recited in claim 22, wherein the location-related information comprises another location-designating information that depends on GSM technologies.

25. A computing device as recited in claim 17, wherein the location-related information is not based on GPS signals, but is based at least on a sensor in the mobile device.

26. A location-aware mobile device comprising:

a retriever configured to retrieve GPS location-designating information acquired by the location-aware mobile device using GPS signals, which are available at the location of the mobile device, wherein the retriever is also configured to retrieve location-related information; and

17

an identifier configured to identify the location of the mobile device based on both the GPS location-designating information and the location-related information; wherein the GPS location-designating information can approximately identify the location of the mobile device,

wherein the location of the mobile device is more accurately or narrowly identified based on at least the location-related information,

wherein the mobile device is configured to be operable as at least a wireless communication device allowing a person to wirelessly send and receive messages with others,

wherein the location-related information is not based on GPS signals, the location-related information being available at the location of the mobile device, and wherein the location-related information depends on at least one Wi-Fi network for location.

27. A location-aware mobile device as recited in claim **26**, wherein the location-related information depends on another location-designating information identifying another location of the mobile device.

28. A location-aware mobile device as recited in claim **27** further comprising a transformer configured to transform the identified location into a location label, wherein the location label pertains to a name used by a plurality of people to designate the location.

29. A location-aware mobile device as recited in claim **28** further comprising:

a storage device configured to store the label; and a query processor configured to search the storage device to identify and retrieve the label.

30. A location-aware mobile device as recited in claim **27**, wherein the mobile device is a mobile phone.

31. A location-aware mobile device as recited in claim **27**, wherein the location-related information includes direction information.

32. A location-aware mobile device as recited in claim **26**, wherein the location-related information is acquired by at least a sensor in the mobile device.

33. A non-transitory computer-readable storage medium including instructions of a computer program for identifying the location of a location-aware mobile device, which is configured to be operable as at least a wireless communication device allowing a person to wirelessly send and receive messages with others, for a user by a method comprising:

retrieving GPS location-designating information acquired by the location-aware mobile device using GPS signals, which are available at the location of the mobile device;

retrieving location-related information that is not based on GPS signals, but uses at least data from a sensor in the location-aware mobile device, the location-related information being available at the location of the location-aware mobile device; and

identifying the location of the mobile device based on both the GPS location-designating information and the location-related information,

wherein the location-related information is obtained from at least one Wi-Fi network to help identify location,

wherein the GPS location-designating information can approximately identify the location of the mobile device, and

wherein the location of the mobile device is more accurately or narrowly identified based on at least the location-related information.

34. A non-transitory computer-readable storage medium including at least executable computer program code tangibly stored therein for identifying the location of a location-aware

18

mobile device for a user, the mobile device being able to be operable at least as a wireless communication device that allows a person to wirelessly send and receive messages with others, said computer readable medium comprising:

computer program code for retrieving location information from the location-aware mobile device using GPS signals, which are available at the location of the mobile device;

computer program code for retrieving related information from the location-aware mobile device using certain wireless signals, which are not GPS signals and which are available at the location of the mobile device; and

computer program code for identifying the location of the mobile device at least based on both the location information and the related information,

wherein the related information depends on Wi-Fi signals to help identify location,

wherein the location information can approximately identify the location of the mobile device, and

wherein the location of the mobile device is more accurately or narrowly identified based on at least the location information and the related information.

35. A non-transitory computer-readable storage medium as recited in claim **34** further comprising computer program code for transforming the identified location into a location label, wherein the location label is a name commonly used by users to designate the location,

wherein the location label is in a database, and wherein the computer-readable storage medium further comprises computer program code for searching the database to retrieve the location label.

36. A non-transitory computer-readable storage medium as recited in claim **34**, wherein the non-transitory computer-readable storage medium is at a computing device, which is configured to use the location information and the related information received wirelessly from the mobile device.

37. A non-transitory computer-readable storage medium as recited in claim **34**, wherein the GPS signals are based on information from at least four satellites.

38. A non-transitory computer-readable storage medium as recited in claim **34**, wherein the related information depends on the mobile device being at a Wi-Fi network that allows the mobile device to gain network access via the Wi-Fi network.

39. A non-transitory computer-readable storage medium as recited in claim **38** further comprising computer program code for transforming the identified location into a location label,

wherein the location label is a name commonly used by users to designate the location,

wherein the location label is in a database, and wherein the computer-readable storage medium further comprises computer program code for searching the database to retrieve the location label.

40. A non-transitory computer-readable storage medium as recited in claim **34**, wherein the related information includes location information that depends on GSM technologies.

41. A non-transitory computer-readable storage medium as recited in claim **40** further comprising computer program code for transforming the identified location into a location label,

wherein the location label is a name commonly used by users to designate the location, and

wherein the location label is in a database, and is linked at least to the location information, which is also in the database.

42. A non-transitory computer-readable storage medium as recited in claim 34, wherein the certain wireless signals are not transmitted from a satellite.

43. A computing device for identifying the location of a location-aware mobile device for a user, the mobile device being able to be operable at least as a wireless communication device that allows a person to wirelessly send and receive messages with others, the computing device comprising:

a receiver configured to wirelessly receive location information from the location-aware mobile device using GPS signals, which are available at the location of the mobile device,

wherein the receiver is also configured to wirelessly receive related information from the location-aware mobile device using certain wireless signals, which are not GPS signals and which are available at the location of the mobile device; and

an identifier configured to identify the location of the mobile device at least based on both the location information and the related information, said identifying including accessing a database that stores at least the location information and the related information;

wherein the related information uses Wi-Fi signals to help identify location,

wherein the location information can approximately identify the location of the mobile device, and

wherein the location of the mobile device is more accurately or narrowly identified based on at least the location information and the related information.

44. A computing device as recited in claim 43, wherein the GPS signals are based on information from at least four satellites.

45. A computing device as recited in claim 43, wherein the related information depends on the mobile device being at a Wi-Fi network that allows the mobile device to gain network access via the Wi-Fi network.

46. A computing device as recited in claim 45 further comprising a transformer configured to transform the identified location into a location label,

wherein the location label is a name commonly used by users to designate the location,

wherein the location label is in the database,

wherein the location label is linked to at least the location information in the database, and

wherein the computing device is further configured to search the database to retrieve the location label.

47. A computing device as recited in claim 43, wherein the related information includes location information that depends on GSM technologies.

48. A computing device as recited in claim 43, wherein the certain wireless signals are not transmitted from a satellite.

49. A location-aware mobile device for a user comprising:

a retriever configured to retrieve (a) location information from the location-aware mobile device using GPS signals, which are available at the location of the mobile

device, and (b) from the location-aware mobile device, related information, which does not use GPS signals, but is based on data from a sensor in the location-aware mobile device, the data being available at the location of the location-aware mobile device; and

an identifier configured to identify the location of the mobile device based on at least both the location information and the related information,

wherein the mobile device is configured to be operable as at least a communication device allowing the user to send messages to one or more other users,

wherein the location information can approximately identify the location of the mobile device, and

wherein the location of the mobile device is more accurately or narrowly identified based on at least the location information and the related information.

50. A location-aware mobile device as recited in claim 49, further comprising a transformer configured to transform the identified location into a location label, wherein the location label is a name commonly used by users to designate the location.

51. A location-aware mobile device as recited in claim 49, wherein the related information includes another location information based on Wi-Fi technologies.

52. A location-aware mobile device as recited in claim 49, wherein the related information depends on the mobile device at a Wi-Fi network that allows the mobile device to gain network access via the Wi-Fi network.

53. A location-aware mobile device as recited in claim 52, further comprising a transformer configured to transform the identified location into a location label, wherein the location label is a name commonly used by users to designate the location.

54. A location-aware mobile device as recited in claim 49, wherein the related information includes location information based on GSM technologies.

55. A location-aware mobile device as recited in claim 49, wherein the messages include emails.

56. A location-aware mobile device as recited in claim 49, wherein the messages include phone calls.

57. A location-aware mobile device as recited in claim 49, wherein the sensor is configured to generate the data based on signals at the location of the location-aware mobile device, and the signals are wireless signals that are not transmitted from a satellite.

58. A location-aware mobile device as recited in claim 49, wherein the sensor is configured to generate the data based on signals at the location of the location-aware mobile device.

59. A location-aware mobile device as recited in claim 49, wherein the related information is based on Wi-Fi signals for location.

60. A location-aware mobile device as recited in claim 49, wherein the GPS signals are based on information from at least four satellites.

* * * * *

UNITED STATES PATENT AND TRADEMARK OFFICE
CERTIFICATE OF CORRECTION

PATENT NO. : 8,611,920 B2
APPLICATION NO. : 11/705339
DATED : December 17, 2013
INVENTOR(S) : Chung Lau, Peter P. Tong and C. Douglass Thomas

Page 1 of 2

It is certified that error appears in the above-identified patent and that said Letters Patent is hereby corrected as shown below:

Title Page, References Cited

On Page 3, Under U.S. Patent Documents

In the left column, "6,937,900 B1 8/2005 Planca et al." should be --6,937,900 B1 8/2005 Pianca et al.--.

On Page 4, Under Other Publications

In the left column, ""An Introduction to SnapTrack Server-Aided GPS Technology," Snaptrack Inc., Feb. 10, 2007" should be --"An Introduction to SnapTrack Server-Aided GPS Technology," Snaptrack Inc.--.

On Page 4, Under Other Publications

In the left column, ""Carrier and end-user applications for wireless location systems," TruePosition, Inc., pp. 1-7, Feb. 10, 2007." should be --"Carrier and end-user applications for wireless location systems," TruePosition, Inc., pp. 1-7.--.

On Page 4, Under Other Publications

In the left column, ""Introduction to SMS," by C. Tull of Anywhere YouGo.com, pp. 1-4 (downloaded: www.devx.com/wireless/articles/SMS/SMSintro-asp), Feb. 10, 2007." should be --"Introduction to SMS," by C. Tull of Anywhere YouGo.com, pp. 1-4 (downloaded:www.devx.com/wireless/articles/SMS/SMSintro-asp).--.

On Page 4, Under Other Publications

In the right column, ""What are Instant Messages?" Yahoo! Messenger Help, Yahoo! Inc., 2002, pp. 1, Feb. 10, 2007." should be --"What are Instant Messages?" Yahoo! Messenger Help, Yahoo! Inc., 2002, pp. 1.--.

Signed and Sealed this
Fifteenth Day of April, 2014

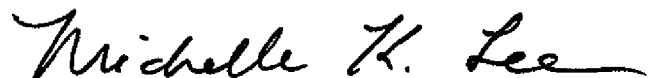

Michelle K. Lee
Deputy Director of the United States Patent and Trademark Office

U.S. Pat. No. 8,611,920 B2

On Page 4, Under Other Publications

In the right column, ““Wherify Wireless GPS Locator for Kids User Guide,” Wherify Wireless, Inc., 2003, pp. 1-106, Feb. 10, 2007.” should be --“Wherify Wireless GPS Locator for Kids User Guide,” Wherify Wireless, Inc., 2003, pp. 1-106.--.

On Page 5, Under Other Publications

In the left column, “Bickers, “Eyes in the sky,” SafeTzone Technology Corporation, webpages, 2001, pp. 1-3 (downloaded: www.safetzone.com/newsKiosk.asp), Feb. 10, 2007.” should be --Bickers, “Eyes in the sky,” SafeTzone Technology Corporation, webpages, 2001, pp. 1-3 (downloaded: www.safetzone.com/newsKiosk.asp).--.

On Page 5, Under Other Publications

In the left column, “Chertkoff, Rachel, “Vehicle Locator Systems,” Paper Technology, pp. 1-2, 1998, Feb. 10, 2007.” should be --Chertkoff, Rachel, “Vehicle Locator Systems,” Paper Technology, pp. 1-2, 1998.--.

On Page 5, Under Other Publications

In the right column, “Smart Antenna, Specification sheet by Axiom Navigation Inc. (www.axiomnav.com), Feb. 10, 2007.” should be --Smart Antenna, Specification sheet by Axiom Navigation Inc. (www.axiomnav.com).--.

On Page 5, Under Other Publications

In the right column, “TruePosition Virtual Brochure (webpage). TruePosition, Inc. Feb 10, 2007.” should be --TruePosition Virtual Brochure (webpage). TruePosition, Inc., 1998-2000.--.

On Page 6, Under Other Publications

In the left column, “Danger Product Overview, 5 pgs., Danger, Inc., Feb. 10, 2007.” should be --Danger Product Overview, 5 pgs., Danger, Inc.--.